

**REGIONAL DISTRICT OF NANAIMO
BYLAW NO. 500.388**

**A Bylaw to Amend Regional District of Nanaimo
Land Use and Subdivision Bylaw No. 500, 1987**

The Board of the Regional District of Nanaimo, in open meeting assembled, enacts as follows:

- A. This Bylaw may be cited as “Regional District of Nanaimo Land Use and Subdivision Amendment Bylaw No. 500.388, 2013”.
- B. “Regional District of Nanaimo Land Use and Subdivision Bylaw No. 500, 1987”, is hereby amended as follows:
 1. By adding Schedule 4C1 – Lakes District and Schooner Cove Community Water System Standards as shown on Schedule ‘1’ which is attached to and forms part of this Bylaw.
 2. By adding Schedule 4D1 – Lakes District and Schooner Cove Community Sewer System Standards as shown on Schedule ‘2’ which is attached to and forms part of this Bylaw.
 3. Under **PART 4 SUBDIVISION REGULATIONS, Section 4.7 Sewage Disposal** the following is added after Section 4.7 (2):
 - 3) Notwithstanding Section 4.7 (1), for lands within the Lakes District and Schooner Cove Community Water and Sewer Standards Area, all parcels shall be serviced by a community sewer system.
 - 4) Notwithstanding Section 4.7 (2), for lands within the Lakes District and Schooner Cove Community Water and Sewer Standards Area, any community sewer system, or part thereof, provided within the subdivision, to service the subdivision or to connect the sewage collection system within the subdivision to a Regional District trunk sewage main shall, be constructed and installed at the expense of the owner of the land being subdivided and shall be carried out in accordance with the standards and specifications set out in Schedule '4D1'.
 4. Under **PART 4 SUBDIVISION REGULATIONS, Section 4.8 Water Supply** by inserting the following after Section 4.8 (2) and renumbering subsequent sections accordingly:
 - 3) Notwithstanding Section 4.8 (1), for lands within the Lakes District and Schooner Cove Community Water and Sewer Standards Area, all parcels shall be serviced by a community water system.
 - 4) Notwithstanding Section 4.8 (2), for lands within the Lakes District and Schooner Cove Community Water and Sewer Standards Area any community water system, or part thereof, provided within the subdivision, to service the subdivision or to connect the water distribution system within the subdivision to a Regional District trunk water main shall, be constructed and installed at the expense of the owner of the land being subdivided and shall be carried out in accordance with the standards and specifications set out in Schedule '4C1'.

5. The Lakes District and Schooner Cove Community Water System Standards and the Lakes District and Schooner Cove Community Sewer System Standards will apply to lands within the Lakes District and Schooner Cove Community Water and Sewer Standards Area as shown on the attached Schedule '3' and legally described as:
- a. Lot 1, District Lots 30 and 78, Nanoose District, Plan 26219, except those parts in Plans 28246, 29574, 30072, 30262, 34675, 36514, 48548 and VIP53001;
 - b. Lot 8, District Lot 78, Nanoose District, Plan 30262;
 - c. District Lot 11, Nanoose District, Except that part outlined in red on Plan 1567 OS, 48548 and VIP59496;
 - d. A portion of the lands legally described as District Lot 7, Nanoose District, Except that part outlined in red on Plan 1567 OS, 48548, VIP59496 and VIP80856;
 - e. A portion of the lands legally described as District Lot 30, Nanoose District, Except those parts in Plans 15193, 26219, 48585, VIP51706, VIP51707, VIP52451, VIP53134, VIP57407, VIP60049, VIP60602 and VIP88308;
 - f. A portion of the lands legally described as District Lot 78, Nanoose District, Except that part shown outlined in red on Plan deposited under DD 19579I; Except Parcels A and B (DD 7528N); and Except those parts in Plans 813R, 1567 OS, 14212, 14250, 14275, 15075, 15193, 22836, 24012, 25366, 26219, 27129, 27206, 29869, 34675, 47638, 48548, 48585, 49669, 50872, 51142, VIP51603, VIP51706, VIP51707, VIP53134, VIP57407, VIP59180, VIP59494, VIP60049, VIP60602, VIP71781, VIP73214, VIP78139, VIP80854, VIP80855, VIP80856, VIP85588 and VIP88308;
 - g. Lot 1, District Lot 78, Nanoose District, Plan 28544;
 - h. Lot 1, District Lot 78, Nanoose District and District Lots 2085, 2086, 2087, 2088 and 2089 Nanaimo District Plan VIP87121;
 - i. Lot 1, District Lot 2090 Nanaimo District and District Lot 78 Nanoose District Plan VIP87122 and,
 - j. District Lot 2084, Nanaimo District, (Commercial Marina) Licence 109021.

Introduced and read two times this 12th day of November, 2013.

Public Hearing held this 12th day of May, 2014.

Read a third time this 27th day of May, 2014.

Adopted this 22nd day of July, 2014.

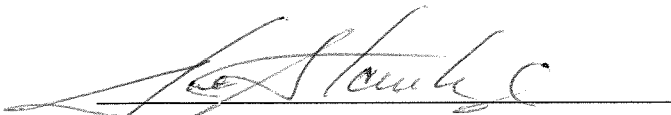

Chairperson

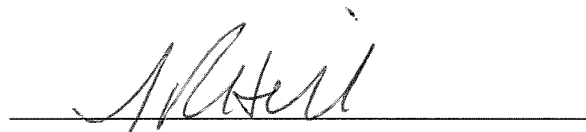

Corporate Officer

Schedule '1' to accompany "Regional District of Nanaimo Land Use and Subdivision Amendment Bylaw No. 500.388,2013"

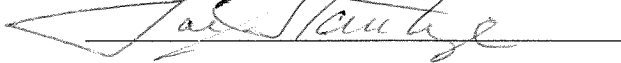

Chairperson



Corporate Officer

Schedule '1'

Schedule 4C1

Lakes District and Schooner Cove Community Water System Standards

REGIONAL DISTRICT OF NANAIMO

BYLAW NO. 500

SCHEDULE 4 C 1

2013 LAKES DISTRICT AND SCHOONER COVE

COMMUNITY WATER SYSTEM STANDARDS

REGIONAL DISTRICT OF NANAIMO
BYLAW NO. 500
SCHEDULE 4 C 1
LAKES DISTRICT AND SCHOONER COVE
COMMUNITY WATER SYSTEM STANDARDS
TABLE OF CONTENTS

1.	GENERAL	1
1.1	Requirement	1
1.2	Design	1
1.3	Definitions	1
1.4	Application	1
1.5	Drawings and Specifications.....	2
1.6	Variations from Standards	3
1.7	Permits	3
1.8	New Service Areas.....	3
1.9	Existing Service Areas.....	3
1.10	Inspection.....	4
2.	DESIGN	4
2.1	Water Demand	4
2.2	Water Pressure.....	5
2.3	Design Population	5
2.4	Hydraulic Network	6
2.5	Water Quality.....	6
2.6	Supply Sources	6
2.7	Storage	10
2.8	Water Distribution Piping.....	12
2.9	Service Connections	13
2.10	Fire Hydrants.....	14
2.11	Valves	14
2.12	Fittings.....	15
2.13	Trenching and Backfill	16
2.14	Pressure Reducing Stations.....	17
2.15	Booster Pump Stations.....	17
2.16	Water Meter Chambers	18
3.	CONSTRUCTION	19
3.1	General.....	19
3.2	Existing Structures and Utility Works.....	20
3.3	Clearing	22

3.4	Trench Alignment and Depth	22
3.5	Pipe Installation.....	23
3.6	Trench Backfill	23
3.7	Repairs.....	23
4.	<i>TESTING AND DISINFECTION</i>	23
4.1	Written Reports.....	23
4.2	Leakage Tests	23
4.3	Flushing	24
4.4	Chlorination.....	24
4.5	Inspection.....	24
5.	<i>TRANSFERRING THE WATER SYSTEM TO THE RDN</i>	25
5.1	Final Inspection by RDN	25
5.2	Preparation/Execution of Transfer Agreement by Developer	25
5.3	Preparation/Execution of Maintenance Agreement.....	25
5.4	Preparation/Execution of Latecomer Agreement.....	25
5.5	Letter of Acceptance of the Works by RDN	26

APPENDICES

Appendix 1	Standard Drawings
Appendix 2	Letter of Assurance
Appendix 3	Certificate of Design
Appendix 4	Certification of Installed Works
Appendix 5	Outline for Wellhead Protection Report
Appendix 6	Standby Irrevocable Letter of Credit

1. GENERAL

1.1 Requirement

The water standards for design and construction of the water system within the Lakes District and the Schooner Cove Community Water Standards Area are to be governed by Regional District of Nanaimo Land Use and Subdivision Bylaw No. 500, 1987, and particular by this Schedule 4C1.

It is the intention of the RDN to enter into a phased development agreement under section 905.1 of the *Local Government Act* with the property owner of the lands within the Lakes District Comprehensive Development Zone CD44 and the Schooner Cove Comprehensive Development CD45 that will specify changes to specified subdivision servicing bylaw provisions that would not apply to the development contemplated under that agreement, unless agreed to in writing by the developer.

The RDN will require a Subdivision Service Agreement to be completed for any new water system or existing system extension, unless otherwise agreed to in writing by the RDN.

Water supply and distribution systems shall be designed, installed, extended, tested and maintained in accordance with the following standards and specifications.

1.2 Design

The engineering design of the water system shall be carried out by, and the preparation of drawings and specifications shall be sealed by a Professional Civil Engineer registered in the Province of British Columbia (the Design Professional), and shall conform to these Standards.

1.3 Definitions

Engineer means the Manager of Engineering Services for the Regional District of Nanaimo, or the person designated by the General Manager of Regional and Community Utilities.

Engineer of Record means a Professional Engineer registered with the Association of Professional Engineers and Geoscientists of BC who is responsible for the construction drawings and documents. The Engineer of Record will be the engineer that signs and seals the record drawings and Certification of Installed Works.

Facilities means water lines, water treatment plants, pumping stations and other works necessary thereto, and for carrying potable water and includes any and all works, structures, lands, conveniences, incidental to and necessary for a water system.

Member Municipality or Member means a municipality or improvement district within the Regional District of Nanaimo.

Regional District means in the document the Regional District shall refer to the Regional District of Nanaimo.

1.4 Application

All applications shall be made in two steps as follows:

1. Feasibility Review

All proposed construction of water supply and distribution facilities shall be submitted to the Regional District for a feasibility review prior to commencement of any detailed design or

construction. Such requests shall include a plan of the proposed construction and the area it will serve. The applicable feasibility review fee, in accordance with RDN Bylaw No. 1259.03 or most recent amendment, and the Letter of Assurance shall also be submitted at this time.

The Regional District will review the proposal, and reply in writing indicating approval or listing the necessary amendments required.

To be addressed but not limited to, are the following items:

- a) source of water
- b) initial plan of the works showing equipment/pipe sizes, materials etc.
- c) number of properties and population served
- d) alignments/offsets of pipes etc.
- e) any flow and/or pressure concerns

2. Detailed Design

The detailed design and specifications shall be submitted in duplicate to the Regional District for Design Stage Approval (DSA) prior to construction and is valid for up to 180 days from the date of issue. Attached to the submission shall be a Certificate of Design. The applicable engineering review fee, in accordance with RDN Bylaw No. 1259.03 or most recent amendment, shall also be submitted at this time, along with the Design Professional's certified cost estimate for the works upon which the fee amount is based.

The detailed plans will be returned either approved or with a request for re-submission. Re-submission will be carried out until the Regional District approves the detailed plans and specifications, and issues Design Stage Approval (DSA).

The Design Professional shall submit the RDN approved plans to the Provincial Ministry of Transportation & Infrastructure and Vancouver Island Health Authority for any approval permits that may be required. Receipt and submission of these permits to the RDN shall also be a prerequisite to the start of construction. Approval permits from other applicable agencies as required shall also be obtained.

1.5 Drawings and Specifications

All design drawings shall be ISO A1 size, 594 mm in depth and 841 mm in width. The following information shall be supplied:

1. **Location Plan** - showing the location of the proposed work. This may appear on the same sheet as the Key Plan.
2. **Key Plan** - showing a plan of the proposed work at a suitable scale such that the whole works are shown on one drawing, usually 1:5000, 1:2000 or 1:1000. The Key Plan shall show a general outline of the works, area covered and sheet numbers of the plan/profile drawings, and a legend showing existing and proposed works.
3. **Plans/Profiles** - showing detailed design of the proposed works. Profiles of mains 200 mm in size and under are not required unless otherwise specified by the Regional District.

Plans shall be drawn at a scale of 1:500 (1:250 is also acceptable), showing the location of the pipe centreline, pipe size and type and off-set from property line, hydrants, valves, fittings and all related appurtenances in relation to road, easement and adjacent property and lot lines. Existing or proposed underground utilities are to be indicated on

the plan in addition to the extent of work required in making connection to existing water main. Location of service connections are to be shown. Connections not conforming to the standard offset require a distance from an iron pin or lot line. In general, water services shall be installed two in a trench at property corners, 1200 mm from the lot line, and alternate with hydro and telephone poles.

Profiles shall be drawn at a horizontal scale of 1:500 and a vertical scale of 1:50 if more suited to specific conditions. The profile shall show the line of the existing and finished road grade on centreline, the invert of the pipe, location of fittings and hydrants, and location of sanitary and storm utilities. Where the pipe is not to be laid at a constant depth below the finished grade, the invert elevation shall be shown at pipe deflections and vertical bends.

Drawings detailing plans and elevations shall be prepared for wells and wellheads, supply intake works, pump stations, major valve chambers, and storage reservoirs. Suitable standard scales shall be chosen, being either 1:50, 1:20, 1:10, or 1:5.

4. **Specifications** - shall be prepared to further define materials of construction and shall specify methods of construction and workmanship.
5. **Record Drawings** - shall be prepared by correcting drawings on completion of construction in order to reflect "as-built" conditions for permanent records. The location of all individual lot water service connections shall be clearly shown. The drawings shall be signed and sealed by the Professional Civil Engineer, and shall be accompanied by a Certification of Installed Works. Final record drawings shall consist of:
 - a) 2 full-size paper sets;
 - b) one full size 3 mil Mylar set;
 - c) 2 – 11" X 17" paper sets or 2 A3 half-size paper sets, as agreed by the RDN; and
 - d) digital copies, one as AutoCAD or Civil 3D file as applicable to the current software, and one as TIFF files.

1.6 Variations from Standards

Where the applicant wishes to vary from these standards he shall submit a written request with adequate supporting data to the Regional District for review.

The Regional District shall make the final decision in writing as to the standard requirements which shall apply.

1.7 Permits

The applicant shall be responsible for obtaining all necessary approvals and permits required prior to commencing construction of the water system.

1.8 New Service Areas

Where a water system is to be constructed by an applicant within an area previously unserved by a community water system, the design and construction for the system shall comply with the requirements of these Standards, unless otherwise agreed to in writing by the Regional District.

1.9 Existing Service Areas

Where a water system is to be constructed by an applicant within the existing or extended boundaries of an area already being served by a community water system, the design and construction of the system shall comply with the requirements of these Standards, with the

understanding that Sections 2.5 and 2.6 may not apply and will be determined by the RDN according to the project and available existing source capacity and water quality.

1.10 Inspection

The Manager of Engineering Services of the Regional District or his appointed deputies shall be allowed access and provided adequate facilities for access to any part of the works at all times for the purpose of inspection.

Any connections to or interruption of any existing system will be under the direct supervision of the Regional District. Adequate notice to the Regional District of any such interruption to service shall be provided in order that attendance by Regional District personnel can be arranged.

The design engineer appointed by the Developer/Owner shall be employed during construction of the works to confirm the project is/has been constructed according to the design drawings and specifications. At the end of the project the engineer shall provide a Certification of Installed Works indicating the works were constructed according to the plans and specifications and meet all applicable codes / regulations / bylaws.

2. DESIGN

2.1 Water Demand

Water sources and primary supply mains shall be designed to supply the maximum day's demand, while distribution mains and booster pump stations must be sized to handle the peak hourly or fire flows. The volume of water in storage acts as a cushion between these differing flows.

The water distribution system shall be designed according to the following minimum demands:

1. Residential

Replacement Section 2.1.1 Water Demand - Residential

Housing Unit	Max Litres per Day per Person	Max Imperial Gallons per Day per Person	Persons Per Household	IGPM per Housing Unit
		(A)	(B)	(A/24/60XB)
Single-Family/detached house	1,168	250	2.2	0.38
Townhouse (attached, semi-detached) unit	914	200	1.9	0.26
Apartment / condominium unit	424	90	1.4	0.09
Secondary suite (carriage house)	424	90	1.1	0.07
Seniors Living unit	424	90	1.1	0.07

2. Commercial and Industrial

Water demands for developments involving commercial or industrial zoned lands shall be in accordance with good engineering practice as determined by the Design Professional and approved in writing by the Regional District.

Replacement Section 2.1.2 Water Demand - Commercial

Non-residential uses			
Commercial – Retail	480	105	Per 1000 sf leasable
Commercial – Office	640	140	Per 1000 sf leasable
Commercial – Restaurant	3500	770	Per 1000 sf leasable
Commercial – Pub	3500	770	Per 1000 sf leasable
Fitness Centre	490	105	Per 1000 sf leasable

3. Fire

Required fire flows shall be in accordance with the "Water Supply for Public Fire Protection - A Guide to Recommended Practice" as published by Public Fire Protection Survey Services, but in no case shall be less than 4.55 m³/min (1000 igpm) for 90 minutes unless approved in writing by the Regional District.

2.2 Water Pressure

Minimum design distribution pressure in all areas at peak demand shall be 276 kPa (40 psi) at the property line. The design engineer shall indicate any building sites where the pressure at the main floor of the building is expected to be less than 207 kPa (30 psi). The developer is expected to file covenants of low pressure on properties where the pressure at the main floor of the building is expected to be less than 207 kPa. With the combination of maximum daily demand and the specified fire flow, the minimum residual water pressure at the fire hydrant shall be 138 kPa (20 psi), and at the highest point in the system shall not fall below 69 kPa (10 psi). Where these minimum design pressures cannot be maintained due to an increase in elevation or distance from the point of connection, a booster pump station and emergency storage shall be provided as part of the distribution system.

The maximum allowable distribution line pressure is 900 kPa (130.5 psi) except where individual connections are permitted directly from trunk mains and where special precautions are taken. Otherwise, where distribution pressures will exceed 900 kPa due to a drop in elevation, a pressure reducing station shall be installed as part of the distribution system. Where distribution pressures exceed 550 kPa (80 psi), occupants in the area shall be required to install individual pressure reducing valves. This valve shall be of an approved design and manufacture.

2.3 Design Population

Design populations used in calculating water demand for residential properties shall be computed in accordance with the population predictions based on the total number of residential units and persons per unit (ppu) as determined by the Regional District from census data or with the persons/hectare (in 2011 an average single family detached home has 2.2 ppu*):

Multiple dwelling unit development	125 persons/hectare
Dwelling unit	30 persons/hectare (12.5 homes/hectare)

Exceptions to these design population densities may be varied by the Regional District of Nanaimo with Board Approval.

2.4 **Hydraulic Network**

Depending on the complexity and extent of the proposed distribution system, the Regional District may require a hydraulic network analysis showing maximum design flows and minimum design pressures. If this information is required, it will be stated by the RDN in writing at the time of the **Feasibility Review** and shall be submitted by the applicant with the detailed design application. The hydraulic network shall be designed to provide the maximum design flows at or above the minimum required pressures specified in this Standard.

2.5 **Water Quality**

1. Water supplied to domestic consumers shall be of a quality meeting the guidelines for microbiological, chemical, and physical parameters listed in the “latest edition” of the Guidelines for Canadian Drinking Water Quality prepared by the Federal-Provincial-Territorial Subcommittee on Drinking Water. All new water source quality shall have parameters equal to or less than the aesthetic objectives (AO) listed in these guidelines. If necessary, treatment of the source water to reduce iron and manganese below AO shall be provided. Exceptions to these parameters may be approved in writing by the Regional District of Nanaimo with Board Approval.
2. All surface water supplies shall be suitably treated and disinfected as per provincial requirements/regulations. Disinfection will normally be solely by chlorination using proportional solution feed, but other approved methods will be considered, including ultraviolet (UV) units, provided residual chlorination is included.
3. Groundwater sources may require chlorination, either at the discretion of the Vancouver Island Health Authority (VIHA), or by the RDN to suit operational requirements such as integrating a new source into an existing chlorinated system. Space shall, as a minimum, be provided for all chlorine storage and associated equipment.

2.6 **Supply Sources**

1. **Groundwater Source**

Where groundwater is to be the source of supply, a copy of the well driller's log shall be submitted, together with a copy of a well completion report by a Design Professional or a professional geoscientist registered in the Province of British Columbia (The Design Professional). All new wells shall be constructed in accordance with the Groundwater Protection Regulations, November 1, 2005, or their most recent amendment or replacement legislation.

Wells shall be cased with a minimum 200 mm (8 inch) diameter steel casing having a minimum stickup of 300 mm (12 inches) above the proposed final ground surface. The well shall be completed with stainless steel screen(s) selected following sieve analysis of aquifer material, and shall have a surface casing of a minimum 250 mm (10 inch) diameter surrounding the 200 mm well casing (unless otherwise approved in writing by

the RDN). The length of the surface casing shall be designed by The Design Professional and shall not be less than 3 meters (10 feet). A surface seal of at least 4.5 meters (15 feet) shall be installed as per the standard contained in the BC Ground Water Protection Regulation. The ground surface around the well head shall be graded to slope away from the well head at 2% grade or greater.

Any wells which encounter bedrock and source water from within rock, shall have well casing driven into the rock to establish a seal and have a surface annular seal placed to the depth at which bedrock is encountered or to a minimum depth of 4.5 meters (15 feet), whichever is less. All wells completed in bedrock must be equipped with PVC liner with threaded joints to allow for removal of the PVC for periodic well maintenance.

Modifications to well casing to allow for shallow subsurface connection, i.e., pitless adapter units, will require that the surface annular seal be re-established. All new wells shall be equipped with a 25 mm (1 inch) diameter PVC monitoring tube for the installation of a standard water level measuring device without danger of being stuck in the well.

The new well shall have a Well Identification Plate as issued by the BC Ministry of Environment attached to the well casing exposed at surface and clearly visible. Copies of all information for the well including the drillers log, pumping test data, analysis and written reports shall be submitted to the BC Ministry of Environment, VIHA and RDN.

The well completion report shall record results of well pumping tests which shall only occur during the late summer or early fall (August, September, October as this time is generally the lowest ground water levels of the year), and contain conclusions as to the capability of the source with the standard MOE 30%percent drawdown safety factor under conditions of zero surface recharge for 120 days (this figure may be reduced 100 days if authorized in writing by the RDN). All interference effects from adjacent constructed wells, on the assumption that they are all fully operational on a continuous basis over the same 120 day period, shall be allowed for in addition to the 30% drawdown safety factor.

No safety factor is required to be added to the interference drawdown allowance although a 15% reduction will be applied as per RDN Board resolution (December 2009) regarding well capacity redundancy and this will be reviewed by the RDN. The Design Professional shall recommend a rated pumping capacity for the well and all wells which will be reviewed by the RDN. The hydrogeologist may require specific pump rates for proper testing.

The Design Professional shall also assess if and what interference effects the new well will have on any adjacent operating RDN system wells. He shall provide an assessment of the effect in total litres per second of capacity reduction which those operating wells are anticipated to have over the 120 day zero surface recharge condition with the new well operating. The new well pump will be required to be sized to the full long term design capacity, but the allowable new supply applicable to support new development will be lowered by any such capacity reduction which it may have on operating RDN wells.

The well pumping test shall be run for 48 hours continuous pumping (72 hours in bedrock wells) at a pumping rate at or above the projected long-term pumping capacity of the well or until the water level stabilizes, whichever is the longest time. Adjacent constructed wells shall be monitored during the test pumping period, to allow The Design Professional to assess interference effects. Well recovery measurements shall

also be carried out immediately on completion of the test pumping period and shall continue until the well has recovered to at least 95% of its initial level (the RDN may reduce this recovery to 80% but this must be authorized in writing by the RDN). A minimum long-term well design capacity rating of 3.8 l/s (50 igpm) is required for any individual well. The minimum standards for pumping test and well capacity can only be altered in writing by the RDN, where under special circumstances wells meeting all quality guidelines and a capacity rating between 2.3 l/s and 3.8 l/s may be considered by the RDN for acceptance. Well testing procedures shall be in accordance with information provided by the BC Government. In no case shall the pumping test be of less time than it takes to produce a relatively stable water level in the well for an adequate period of time, as approved by The Design Professional.

The well completion report shall include a water balance for the aquifer, which accounts for seasonal recharge and withdrawals by users both directly up-gradient and down-gradient of the existing and proposed subdivision lots. All assumptions incorporated into the water balance calculations shall be stated in the report. The well completion report shall also include an assessment of any risk of flooding around the well and indicate what measures have been taken or will be taken to protect the well or wellhead from entry of flood debris or flood waters or physical damage due to flood debris, ice or erosion. Flood proofing shall be in accordance with the Drinking Water Protection regulation, Section 14 and the Ground Water Protection Regulation, Section 11.

The Regional District may require a more extensive quantitative and qualitative report by the Design Professional where unusual conditions or results occur. Further, the RDN may require the information provided by The Design Professional to be reviewed/scrutinized by a third party Design Professional appointed/retained by the RDN and paid for by the developer/well provider.

All new sources of water shall be approved by the Vancouver Island Health Authority (VIHA) and a "source approval" must be issued by VIHA prior to the source being connected to the Regional District of Nanaimo's public water system. VIHA must also approve the well for service in writing. The connection of new properties requiring a new approved source of water shall not be permitted/approved by the RDN until the source is approved by VIHA. A wellhead protection (WHPR) report suitable to the RDN and in the format shown as "Minimum Requirements" shall also be submitted along with the information provided for source approval. Any requirements imposed by VIHA in the source approval shall be completed by the Developer, unless agreed to otherwise in writing by the RDN.

The RDN shall have legal control over a sanitary control area extending from the well head to a radius of 30 to 60 metres based on a wellhead protection report and to the satisfaction of both VIHA and RDN. RDN shall own the property as fee simple around the well head. The sanitary setback areas preferred form of legal control is fee simple ownership, particularly for the first 30 metres, however, if and to the extent that such is not feasible, this may also take the form of a sanitary control easement satisfactory to both VIHA and the RDN.

New sources shall also include provision of a suitable monitoring well that shall be designed and placed near the production well as recommended and designed by the Design Professional. The monitoring well shall be suitably completed and secured at the surface with a Model Solonist Gold (or other model if approved in writing by the RDN) electronic data logger placed at a suitable depth in the monitoring well.

2. Surface Water Source

The proposed use of surface water as a potable water supply source shall be approved by the Board before being considered. Any surface water source shall meet all provincial government regulations and guidelines for siting, for licensing and for treatment etc.

3. Source Pump Stations and Controls

Due to the individual requirements for source pump stations, a standard detail drawing is not provided in these Community Water System Standards. Prior to completing the preliminary design, the design engineer shall request samples of typical recent acceptable source pump stations, and confirm conceptual design requirements. This will be further reviewed, and requirements confirmed by the RDN at the feasibility design review stage.

Wellhead piping shall consist (as a minimum) of a wye strainer, turbine flow meter, air release valves, check valve, gate valve to throttle flows to recommended output with pressure gauges upstream and downstream and mating flanges with adapter coupling to allow installation of an orifice plate to fine-tune pump output, and a 50 mm (2 inch) diameter valved outlet with 62 mm (2.5 inch) diameter fire hose adapter for flushing purposes. A hose bib shall be provided to permit periodic water sampling. The wellhead building or enclosure shall be designed such that future access to the well is available for pump removal or well redevelopment. This shall normally be achieved by installing a pitless adapter on top of the well, protected from vandalism by installation in a non-confined space concrete chamber with spring-assisted aluminum cover and locking lid. A Model Solonist Gold (or other model if approved in writing by the RDN) electronic data logger shall be installed in the well, with data recording equipment and software. Access to install a well-line into the well for periodic manual monitoring of static and pumping levels in the well shall also be provided. Flow recording instrumentation is required. Surface source piping shall be similar in general concept to wellhead piping, modified as agreed with the RDN and to suit the special site circumstances.

The source pump station building shall be designed to provide adequate heating and insulation, lighting and ventilation. The size of the building shall be discussed and determined at the time of the feasibility review. The building shall be of concrete and block work construction, with two isolated rooms, each having separate access doors. One room shall house mechanical piping and electrical controls, and the second room chlorine injection equipment and liquid chemical storage with built-in spill containment. In special circumstances only, the RDN may approve the use of enclosures in lieu of a building, due to site space or access agreement limitations.

Each pump shall have a variable frequency drive combination motor starter with a motor circuit protector, a "hand-off-auto" selector switch, a green "pump run" pilot light, a red "pump failed" pilot light and an elapsed time meter.

Motor starters for submersible well pumps shall be equipped with quick-trip overload relays. Low level draw-down protection shall be provided utilizing electrodes suspended in the well. Restart of the pump shall be automatic when the water level in the well has recovered sufficiently; however, a red alarm light on the control panel shall require manual reset.

If the system consists of more than one pump, supplied from the same service, the control circuits shall be subdivided into branch circuits in such a manner as not to shut down the entire system if one pump circuit develops a fault. Also, time delays shall be provided to permit staggered re-start of the pumps after a power failure.

The pump control panel shall have protection against single-phasing and a red pilot light which will stay on until manually reset after a power failure.

If the system consists of more than one pump, an automatic alternator or manual lead pump selector switch shall be provided.

A single-pole, double-throw (SPDT) contact shall be provided for remote alarm purposes, which will be activated in the event of pump failure, motor overload, and power failure of low well level. Connection of alarm signal outputs to the RDN answering service or alarm centre shall be provided. An external alarm light may also be required for some installations.

Signal cables for pump control shall be directly buried, either alongside connecting pipelines or in a separate trench, wherever feasible. Cable warning tape shall be installed in the trench over signal cables.

For well sources on new systems where very little water-use occurs during the initial operation period until sufficient new users are connected, the RDN may require installation of an approved automatic flushing device, to help in maintaining water quality.

Supervisory control and data acquisition (SCADA) shall be provided from all data outputs to a central location within the new system, normally at the source pump station. The RDN will be responsible for connection of local data to a centralized system, and for any offsite programming requirements which may be required to integrate the new system into the overall water systems SCADA system.

The RDN may require emergency power back-up on all new water sources. This will be determined at time of feasibility review by analyzing system vulnerability.

2.7 Storage

1. Sizing

Reservoirs shall be sized to provide usable water storage volume to meet the fire flow requirements (Section 2.2.1.3) plus 20 percent of a maximum day's demand for the tributary area, and shall be of at least 365 cu. m (80,000 imperial gallons) capacity. The RDN may agree in writing to reduce the reservoir minimum size requirement.

2. Design

The materials and designs used for finished water storage structures shall provide stability and durability as well as protect the quality of the stored water. Unless one or more reservoirs in the same or higher pressure zone within the system are already operational, the reservoir is to be constructed with two independent cells. This is to allow maintenance of one cell to occur, while the second cell remains in service. During the feasibility review, the reservoir design, security features, dimensions, layout and material of construction shall be discussed and agreed with the RDN. Where practical, concrete reservoirs are preferred (although other materials of construction will be considered for acceptance) provided they are designed in accordance with the Building Regulations of British Columbia and amendments thereto. When topography and pressure zone conditions allow, an in-ground reservoir with a minimum 500 mm gravel and soil covering is preferred, for improved seasonal water quality. Steel structures shall

also follow the current AWWA Standards concerning steel tanks, standpipes, reservoirs, and elevated tanks wherever they are applicable.

The foundation may be designed either with the bottom at ground level, bearing on a slab or ring beam or on legs with the bottom in an elevated position.

Foundation design shall be in accordance with Building Regulations of British Columbia and amendments thereto. A foundation or soils investigations report shall be submitted, prepared by a Geotechnical Engineer registered in the Province of British Columbia.

In addition to the seismic requirements of the Building Regulations of British Columbia due account shall be taken of the effects of both convective and impulsive forces generated by ground motion. Sufficient clearance shall also be provided between high water level and roof soffit to allow for wave generation.

The reservoir structure shall be designed to safely withstand all construction and operating loads.

Reservoirs shall be totally enclosed with adequate ventilation, screened and weather protected. Vents shall project above the highest anticipated depth of snow on the roof.

Concrete reservoirs shall be provided with a roof access hatch served by internal and external ladders. Steel reservoirs shall be provided with a roof access hatch served by internal and external ladders and low level access manhole. Roof access hatches shall be of aluminum with spring-assisted opening, and shall be lockable. A roof mounted plate shall be installed alongside the roof access hatch, to suit mounting of the RDN mobile safety winch mechanism, used during internal access operations.

Access ladders, safety cages, and platforms shall comply with the requirements of the Worker's Compensation Board. Chain link and barbed wire fencing of the reservoir site will be required by the RDN, unless otherwise approved in writing by the RDN for specific site location and security conditions.

An altitude gauge shall be provided at an elevation of 1.2 m above the reservoir foundation.

Inlet piping is to discharge into the reservoir above TWL elevation. An approved outlet set 100 mm above the reservoir floor, a valved drain set at floor level, and an overflow pipe with bell-mouth entry set at 200 mm above normal reservoir top water level with 300 mm clearance from underside of roof shall be provided.

Alarms requiring manual reset shall be provided to indicate reservoir high or low level. In a water system consisting of well or booster pumps, these alarms shall be transmitted along buried signal cables to a central location. Controls may utilize probes or transmitters. Where the reservoir is supplied via pumped water, pump start-stop controls will be required. The RDN may require individual start-stop levels for each pump, or staggered pump start-stop on a timer basis.

The Regional District will require the installation of flow meters with flow data transmission and recording from the reservoir outlet. Level monitoring and recording from a level transducer at the reservoir base, or in a chamber immediately on the outlet pipe, shall also be provided.

2.8 Water Distribution Piping

1. Materials

Unless otherwise permitted, the following pipe materials shall be used for water distribution:

Material	Specifications
Steel Pipe	AWWA C200
Ductile Iron Pipe	AWWA C151
PVC Pipe	AWWA C900 - Class 150, DR 18 maximum

All pipe shall be delivered to site with end caps for shipping and storage. Steel pipe shall be coated and lined in accordance with AWWA C203. Ductile iron pipe shall be cement mortar lined in accordance with AWWA C104. Joints shall be rubber gasket in accordance with AWWA C111. Where corrosive soil conditions exist and metal pipe materials are proposed for use, a soil corrosion survey shall be undertaken by an approved professional. The Regional District may require special protection for the pipe. All pipes shall be designed for the maximum pressures and earth loading to which the pipe will be exposed, but in no case shall the design working plus safety factor pressure or class be less than that providing an AWWA standard rating of 1030 kPa (150 psi). Lesser pressure class pipe may only be used when specifically approved otherwise by the RDN for large installations, where no possibility of pressure surges or pressure zone changes occurring, in which cases Class 100 or better rating pipe would be considered.

2. General Layout

Numerous trunk lines and secondary feeders shall be installed throughout the system. These mains must be large enough to deliver consumption and fire flow demands for the district served, and shall be spaced not more than 900 m apart and looped.

Minor distributors and pipes of the gridiron system shall be a minimum of 150 mm in diameter in residential districts with 150 mm diameter cross mains at intervals not exceeding 180 m. Where no longer lengths of pipe are necessary, 200 mm diameter or larger intersecting main shall be used unless initial pressures are unusually high. 200 mm diameter pipe shall be used where dead ends or poor gridironing are likely to exist for a considerable period, or where the layout of the streets and the topography are not adapted to the above arrangement. Lines furnishing domestic supply only, and not serving hydrants, may be 100 mm diameter. Mains in cul-de-sacs shall be looped wherever feasible by connecting through specifically created rights-of-way or parkland, or by twinning pipe installation and looping pipe ends, for improved water quality. Where a water main ends in a dead end, or a valve is normally closed, a fire hydrant or below ground flushout shall be provided for flushing purposes. Temporary above ground flushouts may only be used on those mains intended to be extended in the near future.

In the high value districts, the minimum size shall be 200 mm diameter. Pipe of minimum 250 mm or 300 mm diameter is to be used on major and network highways and roads as identified in the Official Community Plans of the Regional District and for long lines not cross-connected.

2.9 Service Connections

Unless otherwise permitted, only the following materials may be used for service connections:

Material	Specifications
Polyethylene, PE 3406 - N	Potable Series 160 B.137.1
Plastic	ASTM D2666
Soft Copper, Type K	ASTM B88

In general, polyethylene shall be used for new services, except in special approved circumstances, and copper for replacement of existing old service piping by trenchless “pipe splitting” methods.

The minimum size of service connection is 19 mm diameter. Where the length of service between the main and anticipated building frontage exceeds 30 m, the service connection shall be minimum 25 mm diameter. Corporation and curb stops shall be of the same diameter as the service piping. In the larger sizes of service connection piping, the materials specified in Section 2.8 for water distribution may also be used.

Drawing W-7 of this Schedule shows the general arrangement for water service connections. The minimum size of service connection is 20 mm diameter.

Water service connection locations shall be co-ordinated with B.C. Hydro, TELUS (Telephone Company), and Shaw Cablesystems to avoid any conflict with poles (or proposed underground facilities and service conduits for underground utility installations) at the property lines of parcels. Similarly, conflict with Terasen (gas) services shall also be reviewed and avoided.

1. Corporation Stops

Corporation stops shall be in accordance the following supplementary data:

- a) Full port ball valve.
- b) Minimum 150 psi rating.
- c) AWWA x compression.
- d) Compression nut machined to bottom out on valve body shoulder.
- e) Saddle clamps shall be used as specified by the manufacturer.

2. Curb Stops

Curb stops shall be in accordance with the following supplementary data:

- a) Full port ball valve.
- b) Minimum 150 psi rating.
- c) Compression x meter swivel nut.
- d) Compression nut machined to bottom out on valve body shoulder.
- e) Integral locking.
- f) Drain holes not permitted.
- g) Set on main side of meter box to facilitate meter installation when required.
- h) Curb stops shall initially be set in a 100 mm diameter PVC riser pipe, with the meter box to be installed by the RDN on final connection when the building is under construction, unless agreed otherwise. Concrete meter boxes with full support lip

and steel lid drilled for touch-read meter pad shall be provided to the RDN for this purpose.

2.10 Fire Hydrants

Hydrants shall be in accordance with AWWA C502, compression type, factory-painted yellow. The minimum hydrant size shall be 150 mm diameter. The minimum depth of bury shall be 1.2 m. There shall be a minimum of two 65 mm house outlets and one pumper outlet 117.5 mm P4.23, outside diameter male outlet complete with caps per hydrant. One of the outlets shall have an independent shut-off. Opening for both the main hydrant valve and independent shut-off shall be to the left (counter-clockwise). Outlet threads shall conform to the British Columbia Fire Hose Thread Specification. Main valve spindle and outlet nuts shall be standard pentagon shape. Main valve spindle: pentagon in 45 mm circle. Independent spindle: square 16 mm x 16 mm. Drain outlets are to be provided.

Drawings W-12 and W-13 of this Schedule show the general arrangement for the installation of hydrants. Connections shall not be less than 150 mm diameter. A gate valve will be provided on all connections between the hydrant and the main. Installations shall be in general accordance with AWWA M17. The hydrant shall be installed vertical, with the pumper nozzle perpendicular to the priority access road centreline. Mechanical joint thrust restrainers shall be used on all leads up to 6 m length. For longer hydrant leads, approved joint restrainers shall be used at each pipe joint, or alternatively a thrust block shall be installed behind the hydrant 'boot' in accordance with Drawing W-9.

Hydrant distribution shall be in general conformance with the aforementioned Standard of Municipal Fire Protection, but in all cases spacing shall be such that the maximum distance from a hydrant to the centre of any property measured along the centreline of the street and at right-angles to the property is 75 m. Hydrants will be set in 6 m from the corner at any intersection to facilitate future widening or other street works.

2.11 Valves

Unless otherwise permitted, only the following valves shall be installed in the distribution system:

1. Gate Valves

Gate valves shall be in accordance with Drawing W-8, AWWA C500 and the following supplementary data:

- a) Gate valves shall have an iron body, brass mounted.
- b) Valves shall be the same size as the pipe in which they are installed, up to and including 300 mm diameter. In mains over 300 mm diameter, valves may be butterfly type.
- c) Valve ends shall be provided to fit the pipe.
- d) The position of the in line valve shall be vertical.
- e) Stem seals shall be O-ring.
- f) Valves shall open to the left (counter-clockwise).
- g) Gears will be required on valves 400 mm and larger. Gear cases shall be totally enclosed.
- h) Bypasses will be provided on valves 500 mm in diameter and larger.
- i) Valves shall have a 50 mm square operating nut.

2. Rubber Seated Butterfly Valves

Rubber seated butterfly valves shall be in accordance with AWWA C504 and the following specifications:

- a) Valves shall be the same size as the pipe in which they are installed. Valves shall be of wafer style or short body flanged.
- b) Valve ends shall suit the pipe.
- c) Maximum nonshock shutoff pressure shall be suitable for 1030 kPa, bubble tight.
- d) Valves shall be designed for the extreme maximum flows for both opening and closing.
- e) Shaft seals shall be O-ring type.
- f) Valve disks shall be ductile iron.
- g) Valve operators shall be suitable for buried installation and equipped with a standard operating unit.
- h) Valves shall open to the left (counter-clockwise).
- i) Operators are to be located on the side of the valve with the operating spindle in the vertical position.

In general, valves shall be located at intersections and shall be so positioned that no more than 150 m for high value district and 250 m for other areas are isolated in the case of line repairs. In larger trunk and feeder mains where no interconnections are made, the spacing of valves should not exceed 500 m.

Approved joint restraint fittings shall be provided on all valves.

Where valves are located in the roadway, valve boxes shall be Nelson Type of cast iron and telescoping so the surface loads are not transmitted to the valve body of pipeline. A minimum of 200 mm of future adjustment shall be available on all valve boxes for future raising of grade, by locating the top of PVC riser a maximum of 100 mm below the completed asphalt apron grade at the time of initial installation. Cast iron hoods shall be provided on all gate valves 250 mm diameter or larger. In areas where there is no traffic, valve boxes may be as approved by the Regional District.

Valve markers shall be installed to indicate the location of all valves. These markers shall be constructed of 50 mm metal pipe painted sky blue and set in a concrete base. They shall extend 1 m above the ground surface. The markers shall be located 2 m from the property line opposite the valve and the distance to the valve is to be marked in black figures on a flattened upper portion of the marker.

2.12 Fittings

Fittings shall be designed for a minimum of 1030 kPa working pressure and shall be in accordance with AWWA C110. Ends shall be flanged or belled to suit pipe ends. Flanges shall conform in dimension and drilling to ASA B16.1, Class 125. Flange gaskets shall be of natural rubber and shall be 3mm thick with a layer of cotton on both sides. Approved joint restraints shall be used at all fittings, including restraining of a suitable length of pipe each side of the fitting, except at fire hydrant leads over 6 m with unrestrained pipe joints and at main dead-ends, where thrust blocks shall be provided as shown on Drawing W-9 of this Schedule. Thrust calculations for joint restraints shall be carried out in accordance with the manufacturer's specifications, and shown on the design drawings. Length of pipe to be restrained at each fitting shall be clearly shown on each applicable plan drawing, for the varying pipe sizes and fitting configuration.

2.13 Trenching and Backfill

The standard trench section is shown in Drawings W-1, W-2, and W-3 of this Schedule for various conditions. The nominal minimum depth of cover shall be 1.2 m but in no case shall it be less than 1.0 m unless otherwise permitted by the Regional District. Water mains shall be located not less than 3 m centre-to-centre from all sanitary and storm sewer lines, unless otherwise permitted by the Regional District and the Vancouver Island Health Authority.

1. Bedding material shall conform to the following gradation limits:

Gradation Limits
(Percent by Weight Passing)

Sieve Designation	Type 1	Type 2
19.0 mm	100	90-100
12.5 mm		65-85
9.5 mm	85-100	50-75
4.750 mm	70-100	25-50
2.36 mm		10-35
1.18 mm	20-65	
0.850 mm		5-20
0.6 mm	0-45	
0.425 mm		0-15
0.18 mm		0-8
0.15 mm	0-10	
0.075 mm	0-5	0-5

2. Type 1 is the standard acceptable bedding material. Type 2 shall be used where specified by the design engineer to meet special design loading. Dry sieve analysis shall be carried out in checking material gradation.
3. Other acceptable bedding materials, for use only where shown on the construction drawings or as approved by the Engineer, are drain rock, pea gravel or native material. In rock, pipe zone shall have filter fabric between rock and bedding material. Filter fabric shall be non-woven, minimum grade Armtec 200 or equivalent.
4. The bedding material shall cover the full width of the trench bottom and have a minimum depth of 100 mm on completion of compaction. In rock excavation the minimum depth of bedding below the pipe shall be 150 mm after completion of compaction.

5. Bedding material shall be compacted in maximum 150 mm lifts to 95% of Modified Proctor Density (ASTM D1557). Side tamping shall be carried out with bedding material placed to the pipe springline, to provide haunch support.
6. Bedding material shall be placed in such a manner that the pipe is evenly supported throughout its length by the pipe bedding material.
7. Placement and compaction of the bedding material shall not damage or displace the pipe.
8. Bedding material shall be leveled across the full width of the trench to an elevation of 300 mm above the crown of the pipe.

2.14 Pressure Reducing Stations

General requirements for pressure reducing stations shall be as follows:

1. A valved bypass shall be provided.
2. A surge relief valve shall be provided to release pressure in the event of a failure of the pressure reducing valve(s). The surge relief valve may be incorporated into the pressure reducing station or may be located at some other suitable location within the distribution system.
3. Pressure reducing valves shall be sized to provide adequate pressure control through all ranges of design flows. If necessary, two or more pressure reducing valves of varying sizes will be provided in the one station.
4. Each pressure reducing and surge relief valve will be provided with isolating valves and be installed so that individual components may be easily removed for repair or replacement.
5. The whole of the pressure reducing stations shall be enclosed in a reinforced concrete vault with a standard manhole cover and other opening large enough to remove the largest single piece of equipment in the station. Floor drains sloped at 2 percent shall be provided to keep the station dry at all times and shall not be directly connected to any sanitary sewer, or to a storm sewer without a backwater valve in the storm service connection. Drains to the surface are permissible if there is no risk of flooding. Otherwise, underground absorption pits or sump pumps will be required depending on site condition. A permanent access ladder shall be installed.
6. Pressure gauges complete with snubbers shall be installed to register both upstream and downstream pressure.
7. Adequate strainers with dual cartridge filters shall be supplied on the water used for controlling and regulating valves.

2.15 Booster Pump Stations

General requirements for booster pump stations shall be as follows:

1. A valved bypass shall be provided.

2. There shall be sufficient capacity so that, with the most important pump out of service, the station will be capable of supplying the maximum design flow.
3. It may be requested that provision be made to provide the maximum design flow during a power failure. Normally this will be accomplished by means of an elevated storage tank. Where this is not possible, emergency standby internal combustion engines shall be installed either for direct drive or electric generation.
4. Where design flows are such that starting and stopping surges will cause water hammer in the inlet or discharge lines, pump control valves or other pressure control devices shall be provided. Relief valves will also be required to protect against surges caused by power failure.
5. Pumps shall be controlled by automatic devices satisfactory to the Regional District. Flow and pressure measurement shall be provided where required. Flow recording may be required for some installations. Signal cable for pump control shall be directly buried, either alongside connecting pipelines or in a separate trench, wherever feasible. Cable warning tape shall be installed in the trench over signal cables.
6. Pumps shall normally be housed in above ground buildings, designed to provide adequate insulation, heating, lighting and ventilation.
7. Each pump shall have a combination motor starter with a motor circuit protector, a "hand-off-auto" selector switch, a green "pump run" pilot light, a red "pump failed" pilot light and an elapsed time meter.

If the system consists of more than one pump, supplied from the same service, the control circuits shall be subdivided into branch circuits in such a manner as not to shut down the entire system if one pump circuit develops a fault. Time delays shall be provided to permit staggered re-start of the pumps after a power failure.

The pump control panel shall have protection against single-phasing and a red pilot light which will stay on until manually reset after a power failure.

If the system consists of more than one pump, an automatic alternator or a manual lead pump selector switch shall be provided. Time delays or other means suitable to prevent hunting on momentary pressure surges shall be provided.

The pumps shall be shut down and stay locked in the event of motor high temperature or motor overload. The pumps shall also shut down on low suction pressure, however, re-start shall be automatic when the section pressure recovers, except that a red pilot light shall stay on until manually reset.

A single-pole, double-throw (SPDT) contact shall be provided for remote alarm purposes, which will be activated in the event of pump failure, motor high temperature, motor overload, low suction pressure, power failure or standby engine failure (if applicable). Connection of alarm signal outputs to the RDN answering service or alarm centre shall be provided. An external alarm light may also be required for some installations.

2.16 Water Meter Chambers

General requirements for meter chambers on services of 37 mm diameter and larger shall be as follows:

1. An approved meter and double check backflow preventer shall be provided. The meter shall be touch-read style, conforming to the standard meter manufacturer and reading system used by the RDN.
2. Meters shall be sized to meet the anticipated maximum demand required, while providing accurate metering throughout the flow range. Compound meters, or large and small meters installed in parallel, may be required to meet these requirements, particularly where fire flows are to be metered. Pressure loss and maximum velocities shall also be examined. For systems supporting in-building wet fire sprinkler systems, available pressures during flow conditions shall be examined, to ensure adequate operating pressure is maintained at the sprinkler heads.
3. The meter shall be installed in a chamber or chambers, which are of non-confined space access design. Large lids shall be spring-assisted opening, suitable to carry traffic loading unless the location is totally isolated from existing or future traffic, of aluminum construction when feasible.
4. If a sidewalk location is unavoidable for the meter chamber, the box shall be situated to maximize the unobstructed walking corridor.
5. The meter shall be installed in a horizontal plane.
6. A valved by-pass shall be provided for meters 50 mm diameter and larger, to avoid service shutdown during meter maintenance. For combination domestic and fire flow meters, the by-pass shall be sized for the largest flow rate. By-pass and isolation valves may be installed external to the meter chamber.
7. Meter box lid shall be suitable for mounting a touch pit read pad.

3. CONSTRUCTION

3.1 General

1. Access Roads

Temporary roads shall be constructed as required for access to the working areas. Adequate drainage facilities in the form of ditches, culverts, or other conduits shall be installed as found necessary to maintain these roads. In the construction of access roads, existing drainage facilities, natural or otherwise, shall not be disturbed to the detriment of properties outside the working area and such facilities shall, unless otherwise provided elsewhere in the specifications, be restored to their original condition on completion of the work.

2. Sanitary Facilities

Clean, sanitary latrine accommodations shall be provided and shall be located and maintained in accordance with the regulations of VIHA.

3. Special Tools, Operating Manuals, Shop Drawings

With each piece of mechanical and electrical equipment or machinery having wearing parts and requiring periodical repair and adjustment, all special tools, wrenches, and accessories required for removing worn part, making adjustments, and carrying out

maintenance shall be supplied. All gauges, indicators, and lubricating devices necessary for the proper operation of the equipment shall be furnished.

With each piece of equipment, four sets of operating manuals and as-constructed shop drawings shall be supplied. The manuals shall provide the manufacturer's recommended maintenance schedules with the grades of lubricants required, and instructions as to how the equipment may be taken apart for periodical inspection and replacement.

4. Blasting

Blasting will be permitted only after securing the approval of the applicable authorities. Blasting will not be carried out without first verifying that insurance covers any loss of life or damage that may result from this work. The Regional District, in granting approval for blasting, does not in any way assume responsibility for injury, loss of life, or damage that results there from, and such approval shall not be construed as approval of the methods employed in blasting, the sole responsibility therefore being that of the applicant.

5. Site Maintenance and Clean Up

The working area shall be maintained in an orderly manner and shall not be encumbered with equipment, materials, or debris.

Clean up shall be a continuing process from the start of the work to final acceptance of the project. Property on which work is in progress shall at all times be kept free from accumulations of waste materials or rubbish. Accumulations of waste materials, which might constitute a fire hazard, shall not be permitted. Spillage from hauling vehicles on traveled public or private roads shall be promptly cleaned up. On completion of construction, all temporary structures, rubbish, and waste materials resulting from the operations, shall be removed.

6. Erosion and Sediment Control

An Erosion and Sediment Control Plan shall be submitted for review and approval seven days prior to the pre-construction meeting. The Erosion and Sediment Control Plan shall describe the proposed methodology to minimize potential impact on the surrounding environment. The Erosion and Sediment Control Plan shall indicate how the Contractor plans to control sediment discharges from the project and what measures will be put in place to prevent damage to aquatic habitat located downstream.

The work shall be carried out in compliance with the submitted and approved Erosion and Sediment Control Plan and all other environmental laws affecting the work and with the recommendations contained in the most recent edition of the "Land and Development Guidelines for the Protection of Aquatic Habitat" published jointly the Ministry of Environment and Fisheries and Oceans Canada.

For the erosion and sediment control plan, 'environmental laws' means all statutes, regulations, orders, and bylaws relating in any way to the natural environment or its ecosystems, public or occupational health, transportation, storage or handling of contaminants or hazardous materials.

3.2 Existing Structures and Utility Works

1. Scope

Existing structures shall be interpreted as being all existing pipes, ducts, ditches, or other works forming a part of sewerage, drainage, water, telephone, electrical, gas, or

other utility system, as well as sidewalks, curbs, poles, fences, buildings, and other man-made things that may be encountered during construction.

2. Material Supply

Unless specified otherwise, materials supplied for replacement of existing structures shall be at least equal to those being replaced.

3. Location of Structures

Drawings or descriptions, verbal or otherwise, of existing structures or their location that are supplied by the Regional District are intended only as an aid to locating these structures. Measurements and location of the existing underground structures shown on the drawings are not guaranteed to be accurate, and must be verified prior to proceeding with construction.

4. Protection of Structures

Unless authorization from the Regional District is received for their removal, underground and surface structures encountered during construction shall be protected from damage. In the event of damage resulting from the construction operation, structures shall be repaired or replaced to a condition, which is at least the equivalent of that which existed prior to construction.

5. Emergency Situations

In emergency situations resulting from the construction operation, where life or property are endangered, the applicant shall immediately take whatever action is possible to eliminate the danger, and shall also notify the Regional District of the situation.

6. Access Maintained

Existing hydrants, valve or control pit covers, valve boxes, curb stop boxes, fire or police call boxes, and all other utility controls, warning systems, and appurtenances thereof shall not be constructed or made inaccessible at any time by the construction work. Bridges, walks, or other temporary facilities shall be provided as may be necessary to ensure that these controls or warning systems are free for use in their normal manner at all times during construction.

7. Curtailment of Utility Service

Where existing utilities such as water, sewer, electricity, telephone, and gas are serving the public, work shall be planned and executed such that there is no curtailment of service provided by these utilities without prior receipt of approval of the authorities responsible for provision and maintenance of these utilities. The applicant shall obtain the above approvals from the recognized authorities controlling these utilities. If approval for such disruption of utility service is not granted, it may be possible to establish temporary facilities to provide continuous utility service during the course of construction. Such temporary facilities shall only be implemented after receiving the approval of the utility authority.

If approval is received to temporarily shut off an existing utility, individual users of the utility shall be notified at least one hour prior to the time of shut-off.

If there is going to be a shut-off, the Fire Department shall be notified at least one hour prior to shut-off time.

8. Support of Structures

Existing structures shall be protected against damage from settlement by means of timber support or compaction of backfill as required. Where necessary, timber support shall remain in place following backfill of excavations.

Backfill which is placed under or adjacent to the existing structures, which have been undermined during excavation, shall be compacted in a manner which will prevent damage of the structure from settlement. Such backfill shall be of approved granular material suitable for compaction.

On existing piping, this material shall extend horizontally a minimum distance of 600 mm on both sides of the pipe at a level 300 mm above the pipe, and shall slope down from this point at 1-1/2 horizontal to 1 vertical to meet the bottom of the excavation.

9. Drainage Facilities

Existing culverts, enclosed drains, flumes and ditches, and other drainage structures affected by the work but left in place shall be kept clear of excavated material at all times during construction. When it is necessary to temporarily remove an existing drainage structure, suitable temporary ditches or other approved means of handling the drainage shall be provided during construction.

3.3 Clearing

Prior to clearing, the exact limits of the areas on which clearing may take place and whether or not there are restrictions placed on clearing which would result in leaving certain trees, structures, or other existing items in place shall be ascertained.

Prior to trenching, the right-of-way shall be cleared of all standing or fallen brush, timber, stumps, or other debris, which may obstruct the construction operation, damage the completed installation, or detract from the appearance of the site on completion of construction. This material shall be burned or otherwise disposed of to the satisfaction of the Regional District.

The restrictions of all authorities established to control burning in the area shall be complied with. If burning cannot be done on the clearing site, the material shall be hauled to an approved location for burning or disposal. Burning permits, as required, shall be obtained by the applicant.

3.4 Trench Alignment and Depth

Following clearing and prior to excavation of the trench, the location at which the pipe shall be installed shall be established by setting stakes at 20.0 m intervals along a line offset from the centre of the proposed pipeline.

Where pipe is to be installed to a predetermined grade, a cut sheet will be provided showing the depth of the pipe invert relative to the grade stake elevation at the respective locations along the pipeline.

The trench shall be excavated so that pipe can be laid to the established alignment and depth, with allowance made for specified trench wall clearances and bedding as shown in Drawings W-1, W-2, and W-3 of this Schedule for various conditions, or otherwise required.

All trenching and excavations shall be carried out in the manner recommended by the Workers' Compensation Board of British Columbia, or as may be necessary to protect life, property, and structures adjacent to the work and the work itself.

3.5 Pipe Installation

In general, and without limiting the clauses set out in this Standard, pipe shall be installed in accordance with the following specifications:

Ductile Iron Main	AWWA C600
Steel Mains	AWWA C603
PVC Mains	AWWA C900

3.6 Trench Backfill

Trench backfill shall be carried out as shown in Drawings W-1, W-2, and W-3 of this Schedule for various conditions.

3.7 Repairs

Any system approved and built to these standards which requires maintenance work, shall be repaired with materials and construction methods conforming to the specifications contained herein.

4. TESTING AND DISINFECTION**4.1 Written Reports**

The applicant shall submit reports to the Regional District certified by a Design Professional of the tests and chlorination requirements specified herein.

4.2 Leakage Tests

Following final trench backfilling, leakage tests shall be performed on all installed piping.

Leakage tests shall be carried out between valved sections of the installation such that every valve in the system is tested for leakage in the shut-off position.

Leakage tests shall be performed in the following manner. The section to be tested shall be filled with water and all air expelled from the piping. It is recommended that the test section be filled with water for at least 24 hours prior to testing. By pumping water into the test section, the pressure within the piping shall be increased to 0.7 MPa, or 1-1/2 times the system operating pressure at the point of test, whichever is the greater. This pressure shall be maintained constantly in the pipe throughout the duration of the test by the addition of make-up water. The duration of the test section to maintain the specified pressure over the period of test shall be considered to be the leakage.

Piping will not be accepted until the leakage is less than the maximum allowable leakage determined from the following formula:

$$L = ND \times \text{the square root of } P$$

in which L = the allowable leakage in litres per hour,
N = the number of joints in the test section,
D = the nominal diameter of the pipe in millimetre, and
P = the average test pressure during the leakage test in megapascals.

Should any test disclose leakage greater than that specified above, the defect shall be located and repaired, and the section shall be retested to ensure that the leakage is within the allowable limits.

4.3 Flushing

The pipe shall be cleaned of dirt and other foreign materials. The pipe shall be flushed at water velocities of 1.0 m/s, or as high a velocity as can be obtained from the available water sources. Flushing water shall be discharged to watercourses or ditches that have sufficient capacity to carry the flow. Measures shall be taken to avoid any damage to fish habitat or to fish and other aquatic life.

4.4 Chlorination

On completion of the flushing operation, main pipes and services shall be chlorinated. Chlorination procedures shall conform to AWWA C651.

On completion of chlorination, the entire piping system shall be thoroughly flushed of all highly chlorinated water and filled with normal system water at a slow rate to avoid stirring deposits from existing mains, sampled in accordance with VIHA, and following satisfactory test results left in a condition ready for use.

Water reservoirs and storage tanks shall be disinfected in accordance with AWWA C652, and wells in accordance with AWWA C654.

Chlorinated water shall be disposed of in such a way as to not cause harm or damage to fish, vegetation or aquatic life in bodies of water or water courses; all federal and provincial regulations and/or guidelines on disposing of chlorinated water to the environment shall be followed.

4.5 Inspection

The Regional District shall be given 48 hour notice of all tests and chlorination.

5. TRANSFERRING THE WATER SYSTEM TO THE RDN

5.1 *Final Inspection by RDN*

Prior to requesting a Final Inspection, the Design Professional shall submit to the Regional District complete Record Documents, a completed Certification of Installed Works, all applicable test results (chlorination, pressure, leakage, health, commissioning, etc.), and Certificate of Approval for electrical works (pump stations, wells, lighting, controls, etc.) The Final Inspection shall be arranged by the Design Professional on completion of the work. This shall be directed by the Design Professional in the presence of approved representatives of the Regional District and the installation Contractor. A complete list of deficiencies identified during the final inspection shall be prepared by the Design Professional. Once the deficiencies have been satisfactorily rectified, the Design Professional shall so notify the Regional District. The date of the Final Inspection will generally be regarded as the commencement of the guarantee period, unless significant deficiencies critical to the effective operation of the system are found at the inspection, at the discretion of the Regional District.

5.2 *Preparation/Execution of Transfer Agreement by Developer*

The Developer shall prepare and execute a Draft Transfer Agreement for the works and submit the document to the Regional District for review/comment. Once approved by the Regional District the Developer shall complete the document and execute it accordingly and submit to the Regional District for them to execute. The date of the Transfer Agreement shall be the date on which the Regional District executes the document.

5.3 *Preparation/Execution of Maintenance Agreement*

The Developer shall prepare and execute a Draft Maintenance Agreement for the works and submit the document to the Regional District for review/comment. Once approved by the Regional District the Developer shall complete the document and execute it accordingly and submit to the Regional District for them to execute.

The Developer shall guarantee the workmanship and the performance of the work as per the Maintenance Agreement, from the date of acceptance (generally the date on which the Regional District executes the Transfer Agreement) for a period of two years. This shall be additionally secured by way of cash or an irrevocable letter of credit suitable to the Regional District in the amount of 10% of the cost of construction as certified by the Design Professional or \$10,000.00 (whichever is greater). There will be no interest paid on this security.

The RDN may reduce the length of the guarantee period and/or the amount of the security. The RDN may also require additional payment, or payout a credit as appropriate, related to an adjustment of the initial engineering fee to final construction cost values, in accordance with RDN Bylaw 1259.03 or most recent amendment. Any change to the guarantee period, security amount or the engineering fee is required to be in writing.

5.4 *Preparation/Execution of Latecomer Agreement*

Where a latecomer agreement may be applicable to a portion of the costs of the works, as agreed by the Regional District and any other applicable jurisdictions, the Developer shall pay all costs of both the Regional District and the Developer associated with the preparation, execution, and registration of the necessary Latecomer Agreement. The Regional District will assume any internal staff costs involved in planning, reviewing, approving, and administering the Latecomer Agreement preparation, and any administrative and financial costs involved

during the effective time-period of the agreement. Based on current legislation, a Latecomer Agreement expires 10 years after its initial registration.

5.5 Letter of Acceptance of the Works by RDN

Following completion of all the foregoing requirements, the Regional District will issue the formal Letter of Acceptance of the Works.



The Regional District will also issue a written statement that the new works can be connected to the District's existing system. Such connection shall be undertaken by the applicant under the direct supervision of the District or by the District at a cost to the applicant.

**REGIONAL DISTRICT OF NANAIMO
BYLAW NO. 500**

**LAKES DISTRICT AND SCHOONER COVE
COMMUNITY WATER SYSTEM STANDARDS**

APPENDIX 1

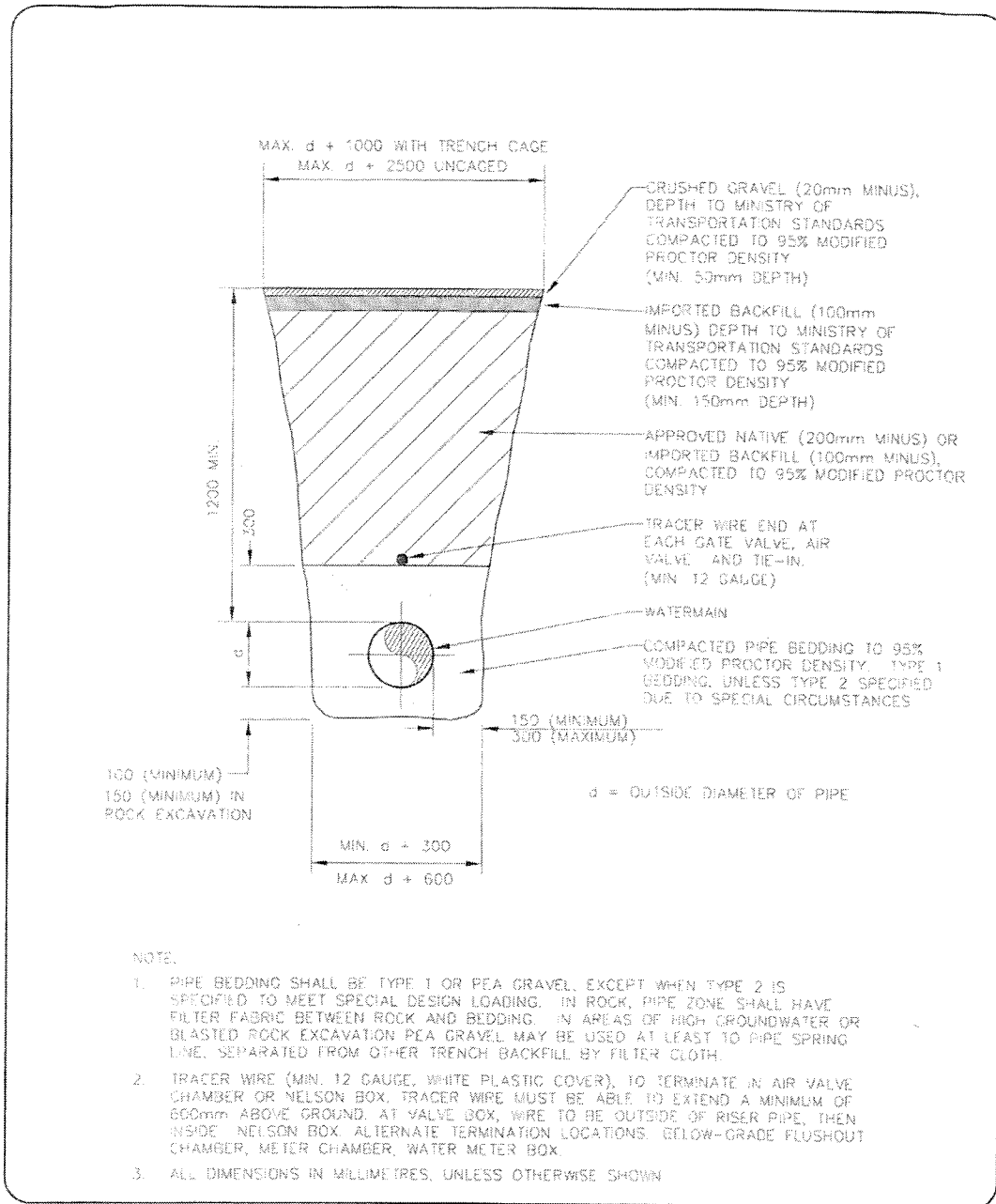
STANDARD DRAWINGS

BYLAW No. 1562
COMMUNITY WATER SYSTEM STANDARDS

**TRENCH DETAIL
SHOULDER AREAS**

REVISIONS		DATE	BY
No.	DATE	DETAILS	APP.
0	03/06	BYLAW UPDATE	W.F.M.

REVISION
0

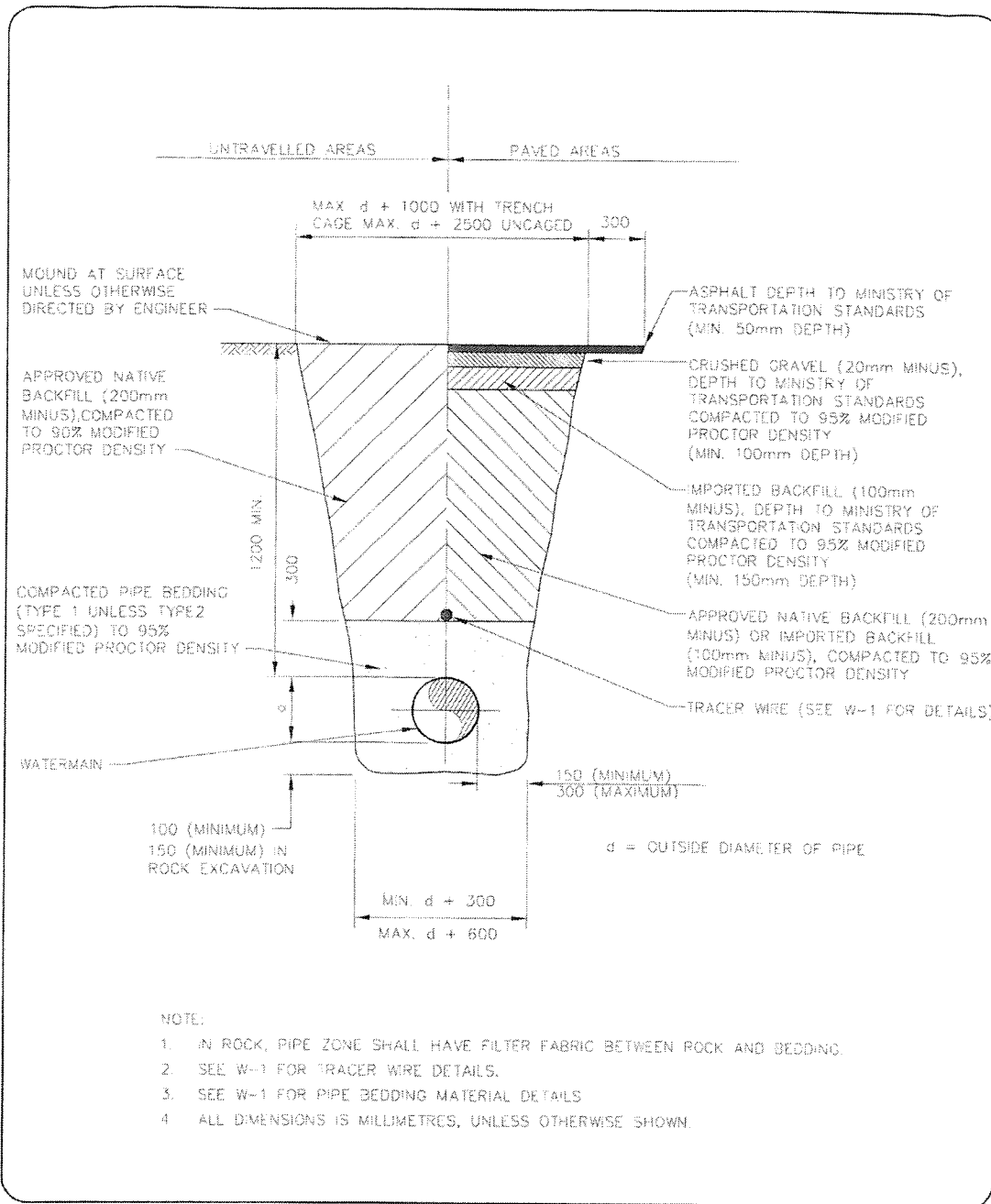

DRAWING No.
W-1



BYLAW No. 1562
COMMUNITY WATER SYSTEM STANDARDS
TRENCH DETAIL
PAVED & UNTRAVELLED AREAS

REVISIONS			APP.
No.	DATE	DETAILS	W.F.M.
0	JUN/06	BYLAW UPDATE	

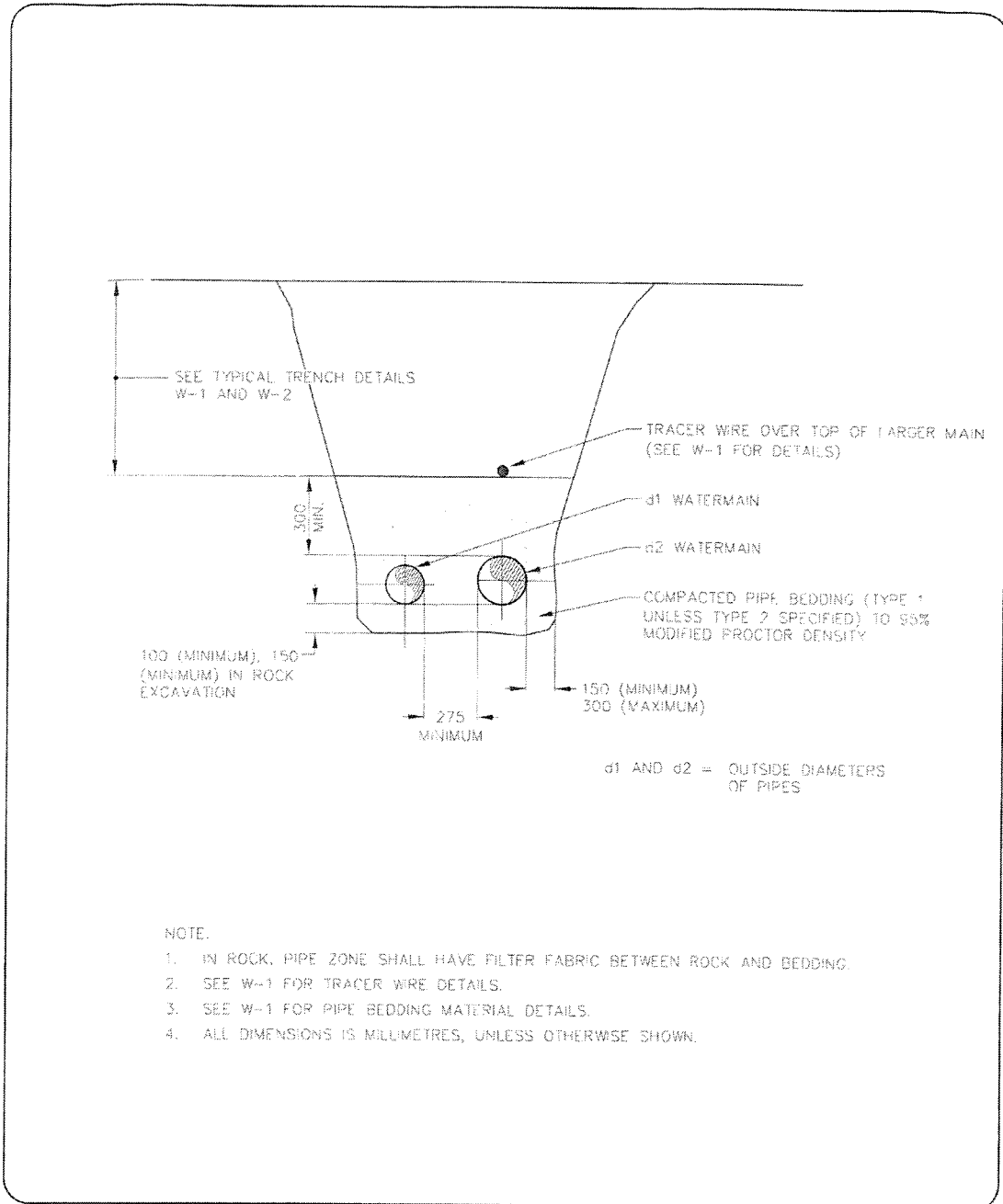
REVISION
0
 DRAWING No
W-2





BYLAW No. 1562
COMMUNITY WATER SYSTEM STANDARDS

**TRENCH DETAIL
TWO PIPES**

REVISIONS		
No.	DATE	DETAILS
0	JUN/06	BYLAW UPDATE
		APR. WFM

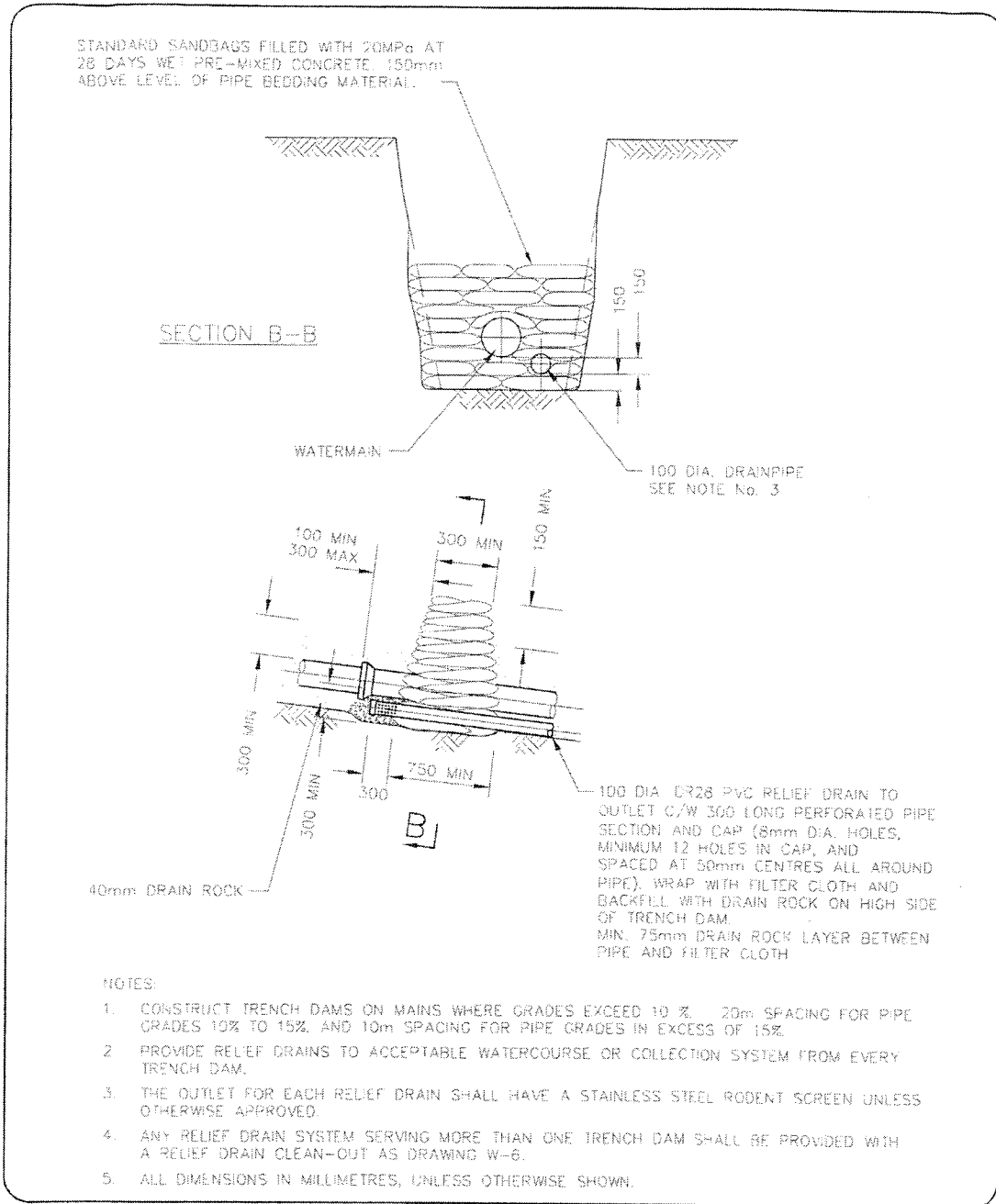
REVISION	0
DRAWING No.	W-3

BYLAW No. 1562
COMMUNITY WATER SYSTEM STANDARDS

TRENCH DAM
SANDBAG CONCRETE TRENCH DAM



No.	DATE	REVISIONS	APP.
0	JUN/06	DETAILS BYLAW UPDATE	W.F.M.

REVISION

0

DRAWING No

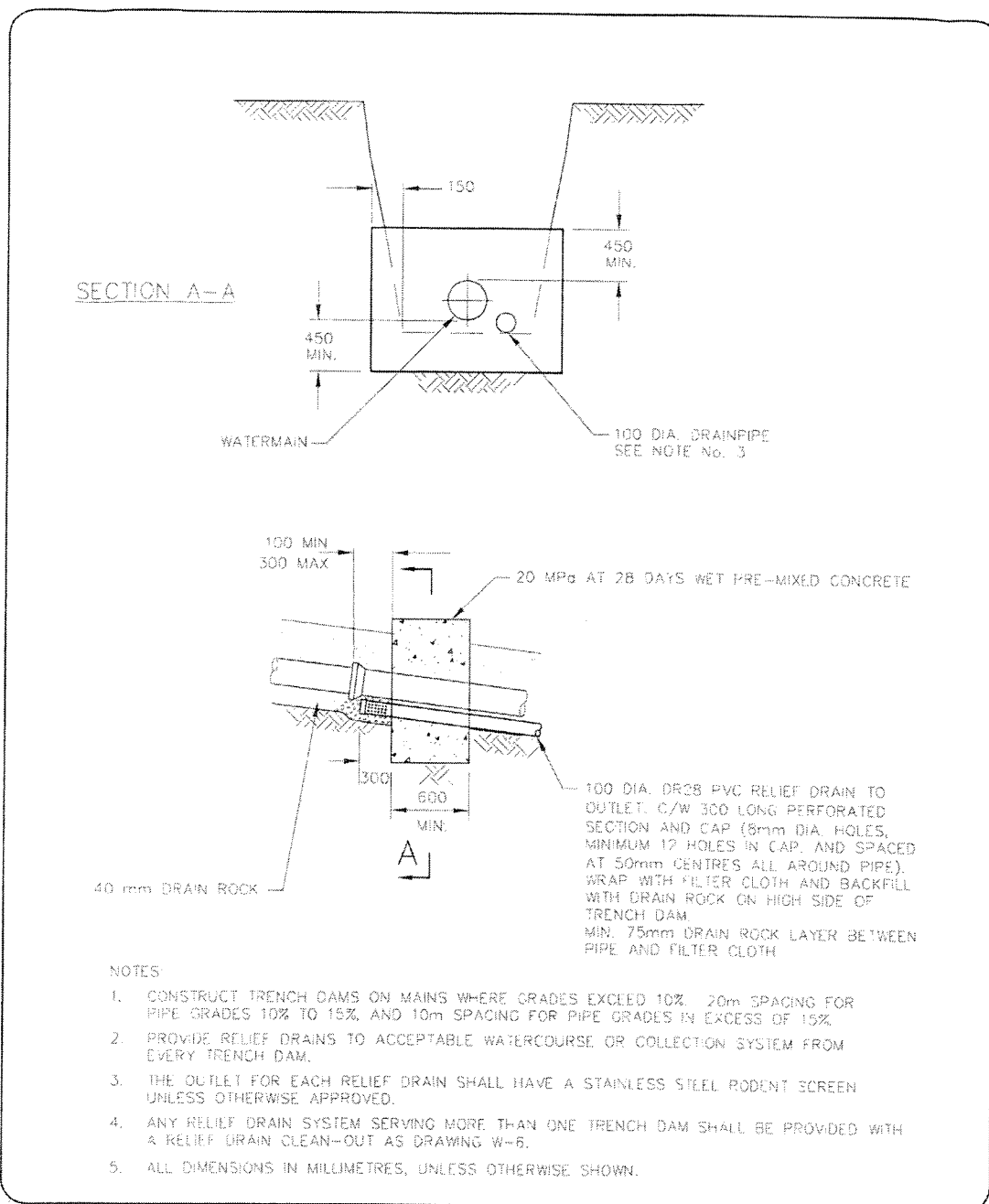
W-4





BYLAW No. 1562
COMMUNITY WATER SYSTEM STANDARDS

TRENCH DAM
FORMED CONCRETE TRENCH DAM

REVISIONS		
No.	DATE	REVISIONS
0	JUN/06	BY LAW UPDATE

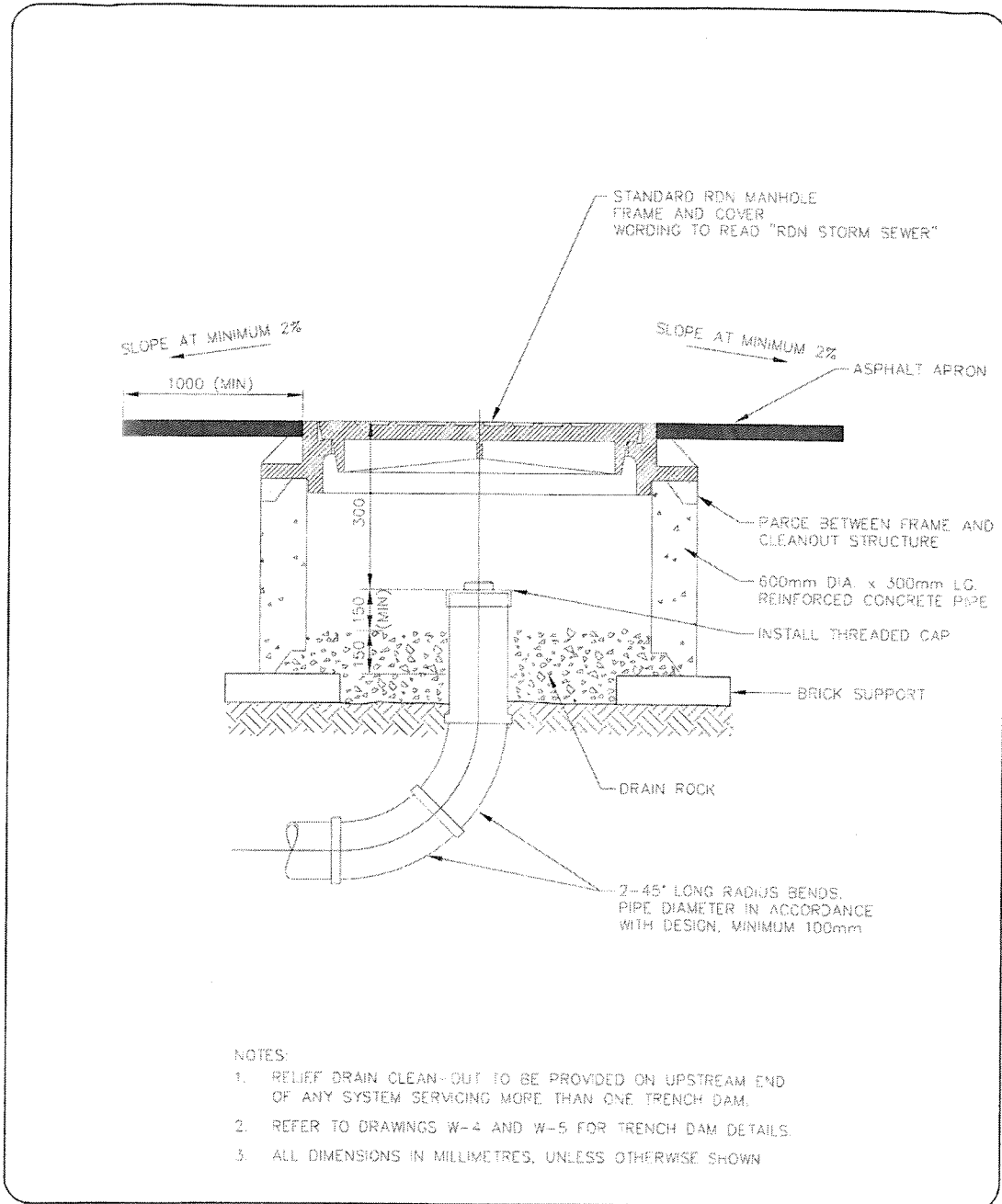
REVISION	0
DRAWING No	W-5

BYLAW No. 1562
COMMUNITY WATER SYSTEM STANDARDS

RELIEF DRAIN CLEANOUT

REVISIONS		APP.
No.	DATE	DETAILS
0	JUN/08	BYLAW UPDATE
		W.F.M.

REVISION

0

DRAWING No

W-6

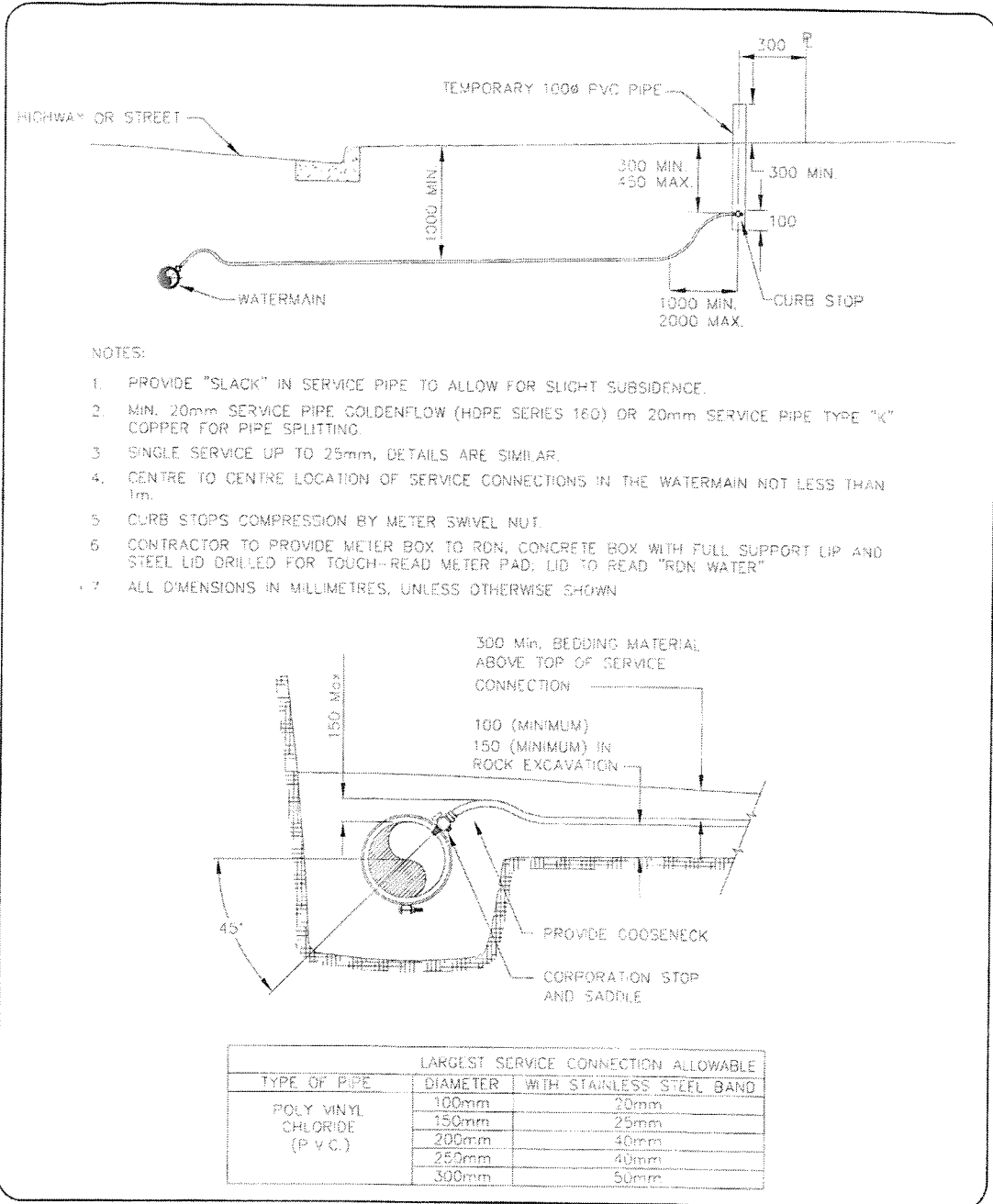

NOTES:

1. PROVIDE "SLACK" IN SERVICE PIPE TO ALLOW FOR SLIGHT SUBSIDENCE.
2. MIN. 20mm SERVICE PIPE GOLDENFLOW (HDPE SERIES 160) OR 20mm SERVICE PIPE TYPE "K" COPPER FOR PIPE SPLITTING.
3. SINGLE SERVICE UP TO 25mm, DETAILS ARE SIMILAR.
4. CENTRE TO CENTRE LOCATION OF SERVICE CONNECTIONS IN THE WATERMAIN NOT LESS THAN 1m.
5. CURB STOPS COMPRESSION BY METER SWIVEL NUT.
6. CONTRACTOR TO PROVIDE METER BOX TO RDN, CONCRETE BOX WITH FULL SUPPORT LIP AND STEEL LID DRILLED FOR TOUCH-READ METER PAD; LID TO READ "RDN WATER"
7. ALL DIMENSIONS IN MILLIMETRES, UNLESS OTHERWISE SHOWN.



BYLAW No. 1562
COMMUNITY WATER SYSTEM STANDARDS
WATER SERVICE CONNECTION

No.	DATE	REVISIONS		APP.
		DETAILS	BY	
0	JUN/06	BYAW UPDATE		WFLM

REVISION
0
DRAWING No.
W-7

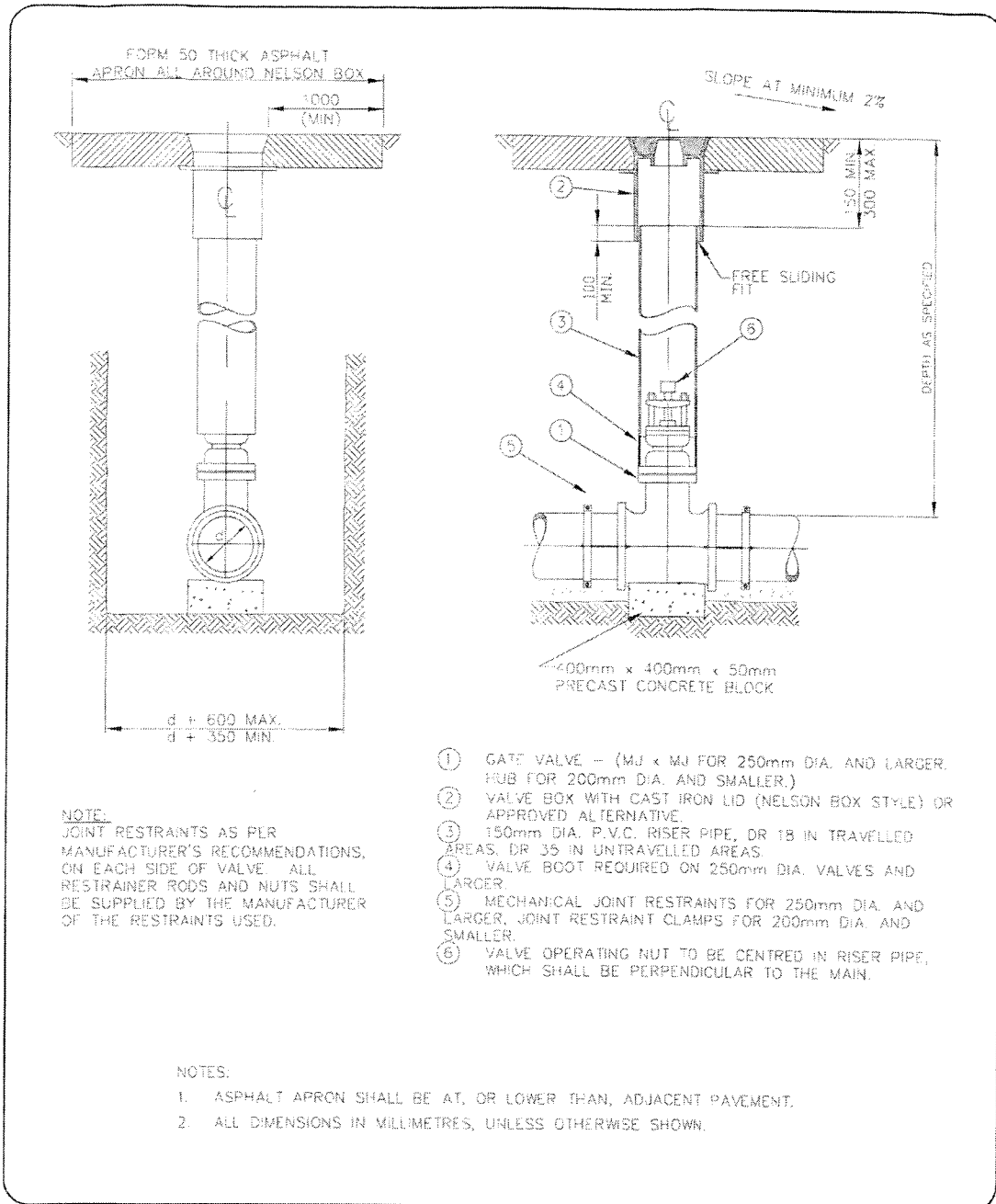

 **BYLAW No. 1562**
COMMUNITY WATER SYSTEM STANDARDS

VALVE

REVISIONS			APP.
No.	DATE	DETAILS	W.F.M.
0	JUN/06	BYLAW UPDATE	

REVISION
0
 DRAWING No.
W-8

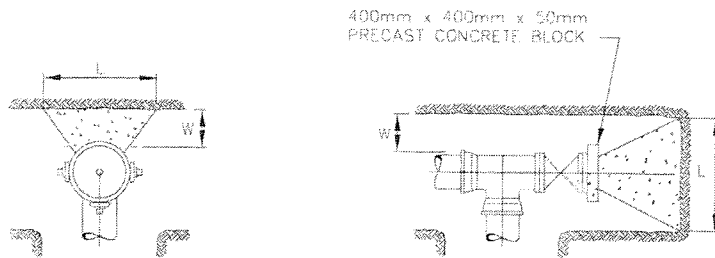

HYDRANT

DEAD-END, CAP, OR BLIND FLANGE

NOTE:
 THRUST BLOCK MAY ONLY BE USED AT END-OF-MAIN HYDRANT. ALL OTHER HYDRANTS SHALL USE MANUFACTURED JOINT RESTRAINT CLAMPS AND MATCHING RESTRAINER RODS AND NUTS.

MINIMUM THRUST AREAS FOR FITTINGS AT 1030kN/m² PRESSURE AND FOR SOILS WITH A MINIMUM BEARING OF 96kN/m² (NOT TO BE USED FOR SOFT CLAY, MUCK, PEAT, ETC.)

FITTING SIZE "D" (mm)	OUTSIDE OF FITTING TO BEARING FACE "W" (mm)	LENGTH "L" (mm)	HEIGHT "H" (mm)
150	300	600	450
200	350	750	600
250	375	975	750
300	400	1200	900
350	425	1300	1000

NOTES:

1. DIMENSIONS APPLY TO THE LARGER DIAMETER END OF FITTING.
2. ALL THRUST BLOCKS TO BE CONSTRUCTED USING TRUCK DELIVERED WET PRE-MIXED CONCRETE ONLY, WITH MINIMUM 28 DAY COMPRESSIVE STRENGTH OF 20MPa.
3. WHERE GROUND CANNOT BE EXCAVATED TO FREE STANDING UNDISTURBED SOIL, UTILIZE THRUST RESTRAINT DEVICES IN PLACE OF THRUST BLOCK.
4. ALL DIMENSIONS IN MILLIMETRES, UNLESS OTHERWISE SHOWN.



BYLAW No. 1562
 COMMUNITY WATER SYSTEM STANDARDS

THRUST BLOCK DETAILS

REVISIONS			APP.
No.	DATE	DETAILS	
0	JUN/06	BYLAW UPDATE	W.F.M.

REVISION
0
DRAWING No
W-9

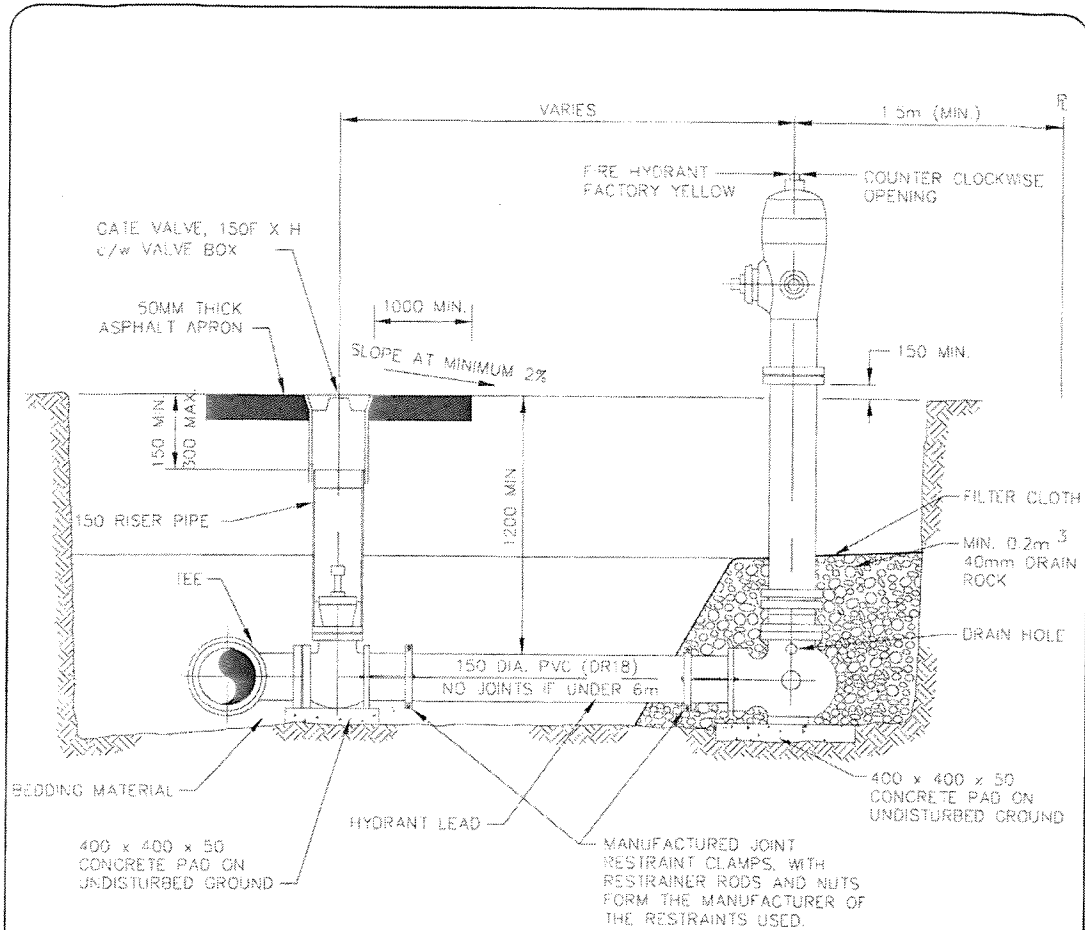

NOTES:



1. PUMPER NOZZLE PERPENDICULAR TO ROAD CENTRELINE
2. HYDRANT TO BE INSTALLED VERTICAL.
3. MANUFACTURED JOINT RESTRAINTERS TO BE USED AT EVERY PIPE JOINT FOR HYDRANT LEADS OVER 6m IN LENGTH. RESTRAINTS REQUIRED AT HYDRANT BOOT AND VALVE FOR LEADS 2m TO 6m LONG. LEADS LESS THAN 2m MAY BE RESTRAINED USING 2-20mm DIA STAINLESS STEEL THREADED RODS c/w SS NUTS AND SS WASHERS.
4. END-OR-MAIN HYDRANT SHALL BE FULLY RESTRAINED AS PER MANUFACTURER'S RECOMMENDATIONS, OR MAY USE A THRUST BLOCK (SEE W-9 FOR DETAILS).
5. ASPHALT APRON SHALL BE AT, OR LOWER THAN, ADJACENT PAVEMENT
6. WHERE CURB/CUTTER DOES NOT EXIST, PAVE FROM EDGE OF ROAD SURFACE TO 1m BEHIND HYDRANT AND 2m WIDE.
7. ALL DIMENSIONS IN MILLIMETRES, UNLESS OTHERWISE SHOWN.



BYLAW No. 1562
COMMUNITY WATER SYSTEM STANDARDS
FIRE HYDRANT ASSEMBLY

REVISIONS		
NO.	DATE	DETAILS
0	JUN/06	BYLAW UPDATE

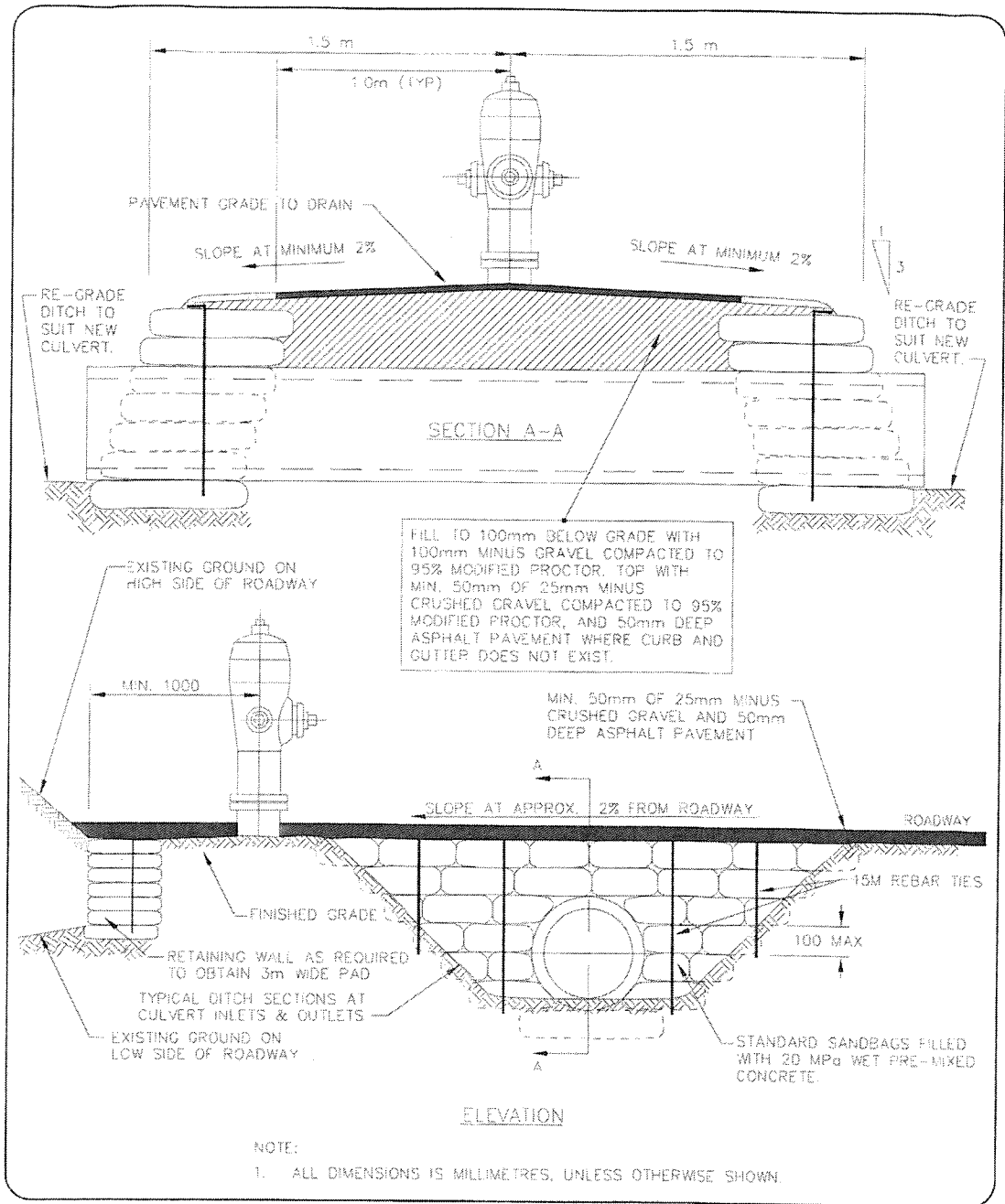
REVISION
0
DRAWING No.
W-12





BYLAW No. 1562
COMMUNITY WATER SYSTEM STANDARDS
HYDRANT ACCESS CULVERT

REVISIONS		
No.	DATE	DETAILS
0	JUN/06	BYLAW UPDATE

APP. W.F.M.

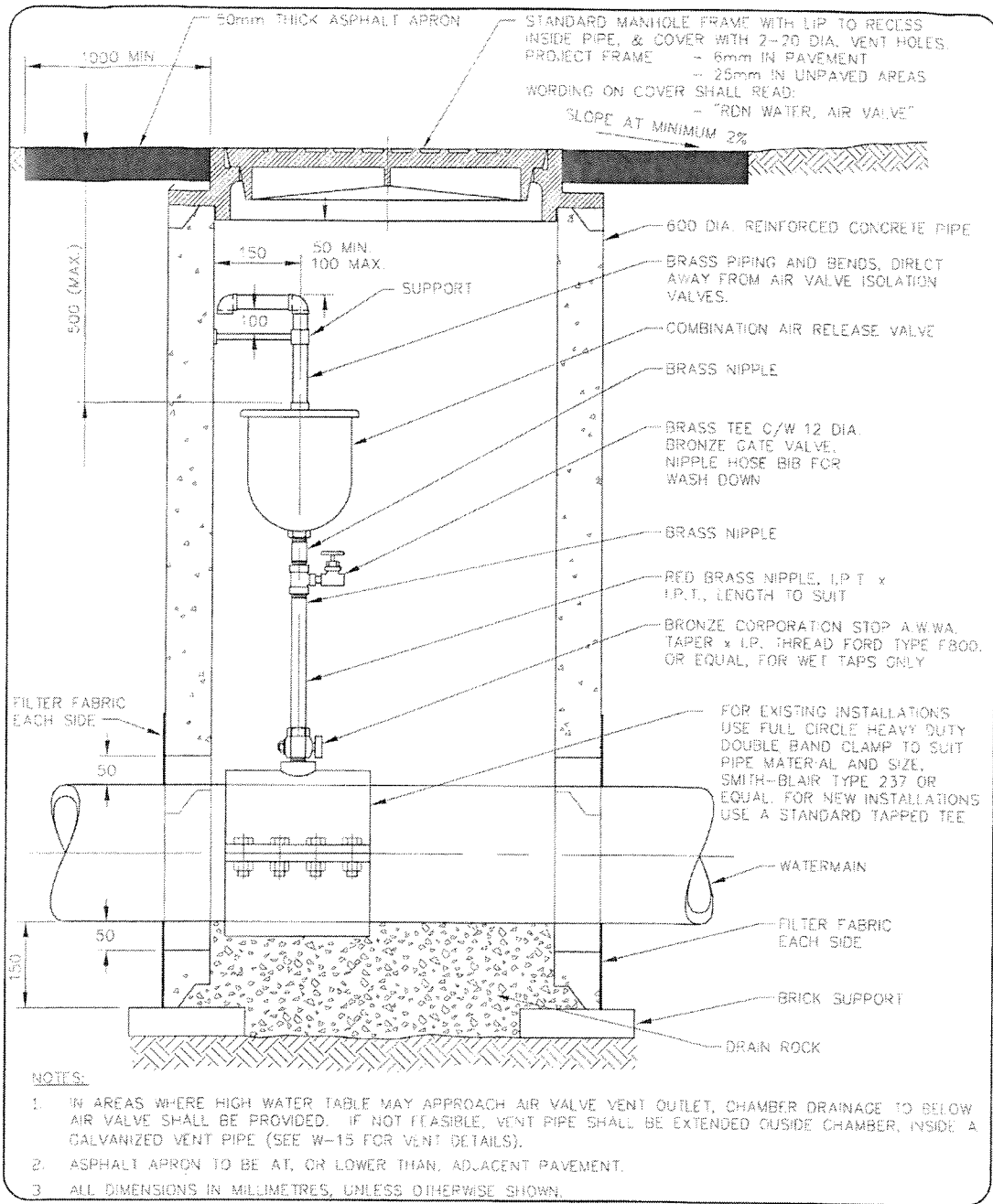
REVISION
0
DRAWING No
W-13

BYLAW No. 1562
COMMUNITY WATER SYSTEM STANDARDS
AIR VALVES UP TO 50mm DIAMETER



REVISIONS		
No.	DATE	DETAILS
0	JUN/06	BYLAW UPDATE

REVISION

0

DRAWING No

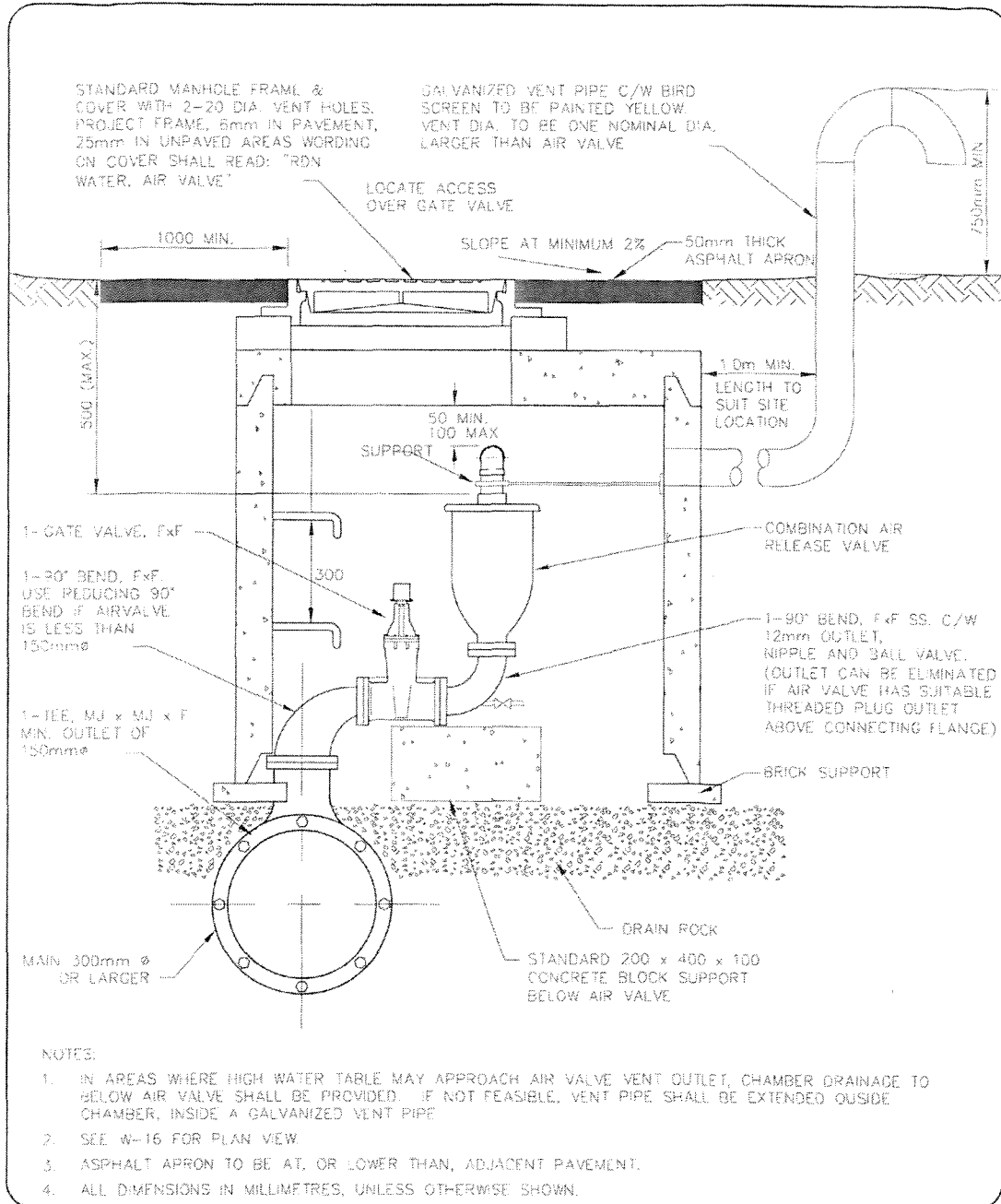
W-14





BYLAW No. 1562
COMMUNITY WATER SYSTEM STANDARDS
AIR VALVE 75mm DIA. AND LARGER SECTION

REVISIONS		
No.	DATE	DETAILS
0	JUN/06	BYLAW UPDATE

APR. W.F.M.

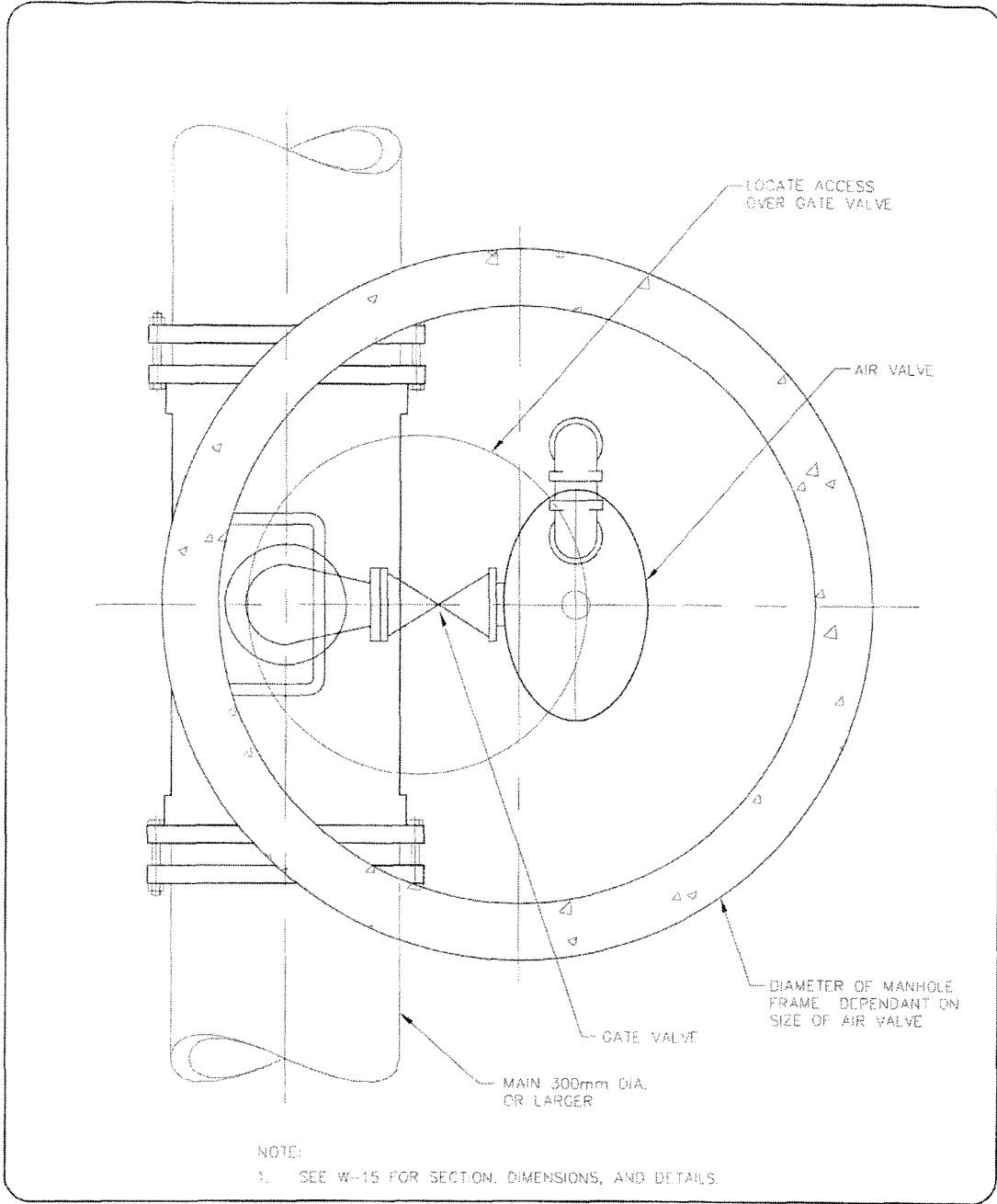
REVISION
0
 DRAWING No
W-15

BYLAW No. 1562
COMMUNITY WATER SYSTEM STANDARDS

**AIR VALVE 75mm DIA. AND LARGER
PLAN**

No.	DATE	REVISIONS		APP.
		DETAILS	BYLAW UPDATE	
0	JUN/05			W.F.M.

REVISION

0

DRAWING No

W-16

**REGIONAL DISTRICT OF NANAIMO
BYLAW NO. 500**

**LAKES DISTRICT AND SCHOONER COVE
COMMUNITY WATER SYSTEM STANDARDS**

APPENDIX 2

LETTER OF ASSURANCE

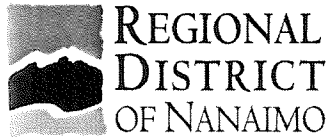

LETTER OF ASSURANCE

NOTE:

To be submitted at time of Feasibility Review

To: Manager of Engineering Services
 Regional District of Nanaimo
 6300 Hammond Bay Road
 Nanaimo BC V9T 6N2

RE: _____

 (Project)

Date: _____, 20__.

This will confirm that (Developer _____) has retained (Consultant _____) to provide, design, contract administration, inspection and as-constructed drawings for this project all in accordance with the current bylaws and standards of the Regional District and in accordance with good engineering practice.

(Developer)

This confirms we have accepted this assignment on the above terms.

(Consultant)

**REGIONAL DISTRICT OF NANAIMO
BYLAW NO. 500**

**LAKES DISTRICT AND SCHOONER COVE
COMMUNITY WATER SYSTEM STANDARDS**

APPENDIX 3

CERTIFICATE OF DESIGN



CERTIFICATE OF DESIGN

I, _____, a Professional Engineer registered in the Province of British Columbia, hereby certify that the works as herein set out on the attached drawings entitled _____

_____ have been designed in accordance with the Regional District of Nanaimo Bylaw 500 and/or in accordance with good engineering practice where such design is not covered by the Regional District Bylaw 500.

I have been retained to provide design, supervision, full-time inspection, as-built drawings, and final certification for this project by:

(Name of Client)

I am satisfied that in the contractual mandate which exists between myself and my client, the terms of reference will permit me to render a level of supervision of the construction work which will allow me to put my name and seal to the "Certification of Installed Works" required by the Regional District of Nanaimo, a sample of which is attached to this document and initialed by me.

In the event that my client releases me from this project, or in the event that I find the terms of reference do not permit me to render a level of supervision of the construction work which will allow me to put my name and seal to the form of certification required by the Regional District of Nanaimo, I will notify the Regional District within twenty-four (24) hours verbally and follow it up with written confirmation and clarification.

Signed this _____ day of _____, 20____.

_____, P.Eng.

(signature)

(name printed)

I understand that the "Certification of Installed Works" is to be completed in this format and submitted with the "as-constructed" drawings.

(Engineer)

Initial	Initial
---------	---------

**REGIONAL DISTRICT OF NANAIMO
BYLAW NO. 500**

**LAKES DISTRICT AND SCHOONER COVE
COMMUNITY WATER SYSTEM STANDARDS**

APPENDIX 4

CERTIFICATION OF INSTALLED WORKS

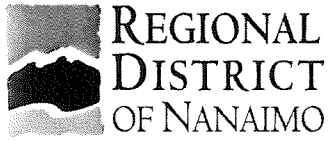

CERTIFICATION OF INSTALLED WORKS

NOTE: To be completed in this format and submitted with the 'As-Built' drawings

Location of the Construction Site and Works: (Legal Description / Location)

all within the Regional District of Nanaimo, British Columbia.

I, _____, a Registered Professional Engineer (Reg. No. _____) in the Province of British Columbia, hereby certify:

1. THAT the following construction tests were carried out to confirm that construction met the specifications required:
 - a) _____
 - b) _____
 - c) _____
 - d) _____
 - e) _____
 - f) _____

2. THAT I was able to monitor the construction and provide a level of supervision of the construction work sufficient to be able to confirm that the specifications in force and effect by the Regional District of Nanaimo and in the applicable design drawings for the said Works were generally met during the Construction Period; and

3. THAT the accompanying plans labeled:
 - (i) _____
 - (ii) _____
 - (iii) _____

accurately record the materials, grades, inverts, offsets and dimensions of the constructed work.

DATED this _____ day of _____, 20 _____.

Engineer (signature & seal)

Engineering Firm

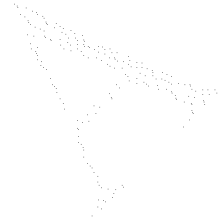

Initial	Initial
---------	---------

**REGIONAL DISTRICT OF NANAIMO
BYLAW NO. 500**

**LAKES DISTRICT AND SCHOONER COVE
COMMUNITY WATER SYSTEM STANDARDS**

APPENDIX 5

**OUTLINE FOR WELLHEAD PROTECTION REPORT
(MINIMUM REQUIREMENTS)**

OUTLINE FOR WELLHEAD PROTECTION REPORT

(Version: November 19, 2009)

Acceptable Preliminary Well Head Protection Plan (WHPP) for New Wells supplied to the RDN by/for private land development (to be prepared by a qualified professional in ground water and well head protection and approved by the RDN prior to appointment).

Below are the minimum requirements for this Document:

Name of the Plan (WHPP), describe the well #'s, legal location of well(s), client, development for which the well is being provided and client file number.

1.0 INTRODUCTION

2.0 BACKGROUND

- 2.1 SITE DESCRIPTION (including a sketch of the current and proposed lot boundaries, locations of wells on current and proposed lots plus on adjacent properties, locations of sewage disposal fields, drainage ditches, dry wells or infiltrations areas, all surface bodies [either permanent and/or intermittent] and other relevant information)
- 2.2 OVERVIEW OF WELL PROTECTION PLANNING
- 2.3 SCOPE OF WORK

3.0 NOTES of MEETINGS with RDN, DEVELOPER, CONSULTANT, etc.

4.0 NOTES of DISCUSSIONS WITH VIHA STAFF

5.0 HYDROGEOLOGIC CONDITIONS

- 5.1 CLIMATE
- 5.2 TOPOGRAPHY AND SURFACE WATER DRAINAGE
- 5.3 GEOLOGY
- 5.4 LOCAL AQUIFERS (include sketch showing aquifer extent and boundaries if present, well head and static water level elevation, areas of recharge and discharge and direction of groundwater flow under natural conditions)
- 5.5 LOCAL GROUNDWATER USE (number and location of wells and estimates of seasonal water use)
- 5.6 WATER QUALITY (identify where the water quality exceeds guidelines and specifically iron and manganese)
- 5.7 NEW AND EXISTING WELLS ON PROPOSED LOTS (to include information on total well depth and depth of fractures producing groundwater or well screens. Also include testing and yield evaluation results. All pumping test data and well logs to be included with report)
- 5.8 COMPLIANCE OF WELLS WITH BC GROUNDWATER PROTECTION REGULATIONS
- 5.9 ASSESSMENT OF POTENTIAL FOR MUTUAL WELL INTERFERENCE

**6.0 CURRENT ZONING OF WELL HEAD AND PROPOSED AND ADJACENT CURRENT LAND USE
(within minimum 1 kilometre of well(s))**

7.0 PRELIMINARY WELL HEAD PROTECTION PLAN

7.1 WELL HEAD PROTECTION AREA

7.2 AREAS OF POTENTIAL ENVIRONMENTAL CONCERN

7.2.1 WELLS AS A POTENTIAL CONDUIT TO THE SUB-SURFACE

7.2.2 SEWAGE DISPOSAL SEPTIC FIELDS

7.2.3 STORMWATER DISPOSAL

7.2.4 HEATING OIL ABOVE GROUND AND UNDERGROUND STORAGE TANKS

7.2.5 HISTORICAL OPERATIONS (ON SITE AS WELL AS ADJACENT TO SITE)

7.2.6 POTENTIAL FOR SALTWATER INTRUSION

7.3 DETERMINATION OF WELL HEAD CAPTURE ZONE (include background on methodologies to determine zones, why specific method was used and assumptions incorporated into analysis)

7.4 RECOMMENDATIONS FOR WELL PROTECTION AREA MANAGEMENT

7.4.1 WELL CONSTRUCTION AND CLOSURE ISSUES

7.4.2 SEWAGE DISPOSAL SEPTIC FIELD SYSTEMS

7.4.3 STORMWATER DISPOSAL MANAGEMENT

7.4.4 HEATING OIL UNDERGROUND STORAGE TANKS

7.4.5 MONITORING SPECIFIC TO SALTWATER INTRUSION

7.4.6 WATER QUALITY MONITORING

8.0 CONCLUSION AND RECOMMENDATIONS (ALSO INCLUDE ANY COST ASSOCIATED WITH RECOMMENDATIONS)

9.0 COMMITMENT FOR ANNUAL MONITORING AND REPORTING ON WHPP TO RDN

**REGIONAL DISTRICT OF NANAIMO
BYLAW NO. 500**

**LAKES DISTRICT AND SCHOONER COVE
COMMUNITY WATER SYSTEM STANDARDS**

APPENDIX 6

STANDBY IRREVOCABLE LETTER OF CREDIT

[BANK LETTERHEAD]

Letter of Credit No.	_____	Amount:	_____
Applicant	_____	Initial Expiry Date:	_____
	_____	Beneficiary:	_____

For the account of _____
(Name of Customer)

up to an aggregate amount of _____ available on demand.

Pursuant to the request of our customer, we hereby establish and give you a Standby Irrevocable Letter of Credit in your favour in the above amount which may be drawn on by you at any time and from time to time, upon written demand for payment made upon us by you, which demand we shall honour without enquiring whether you have the right as between yourself and the said customer to make such demand, and without recognizing any claim of our said customer, or objection by it to payment by us.

This Letter of Credit relates to those Regional District of Nanaimo services and financial obligations set out in an Agreement between the customer and the Regional District of Nanaimo and briefly described as:

The amount of this Letter of Credit may be reduced from time to time as advised by notice in writing to us by the Regional District of Nanaimo.

Partial or full drawings may be made.

This Letter of Credit shall expire at 3:00 p.m. on _____. This Letter of Credit will continue in force for a period of 1 year, but shall be subject to the condition hereinafter set forth.

It is a condition of the Letter of credit that it shall be deemed to be automatically extended without amendment from year to year from the present or any future expiration date hereof, unless at least 30 days prior to the present or any future expiration date, we notify you in writing by registered mail, that we elect not to consider this Letter of Credit to be renewable for any additional period. This Letter of Credit is subject to the Uniform Custom and Practice for Documentary Credits (1993 Revision) International Chamber of Commerce Publication No. 500.

DATED at _____, British Columbia, this ____ day of _____, 20__.

(Name of Bank)

(Address of Bank)

PER:

(Authorized Signature)

Schedule '1' to accompany "Regional District of Nanaimo Land Use and Subdivision Amendment Bylaw No. 500.388, 2013".

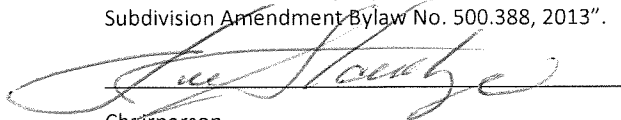

Chairperson



Corporate Officer

Schedule '2'

Schedule 4D1

Lakes District and Schooner Cove Community Sewer System Standards

REGIONAL DISTRICT OF NANAIMO

BYLAW NO. 500

SCHEDULE 4 D 1

2013 LAKES DISTRICT AND SCHOONER COVE

COMMUNITY SEWER SYSTEM STANDARDS

REGIONAL DISTRICT OF NANAIMO
LAKES DISTRICT AND SCHOONER COVE
2013 COMMUNITY SEWER SYSTEM STANDARDS
TABLE OF CONTENTS

- 1. GENERAL..... 2**
 - 1.1. Requirement..... 2
 - 1.2. Design 2
 - 1.3. Definitions..... 2
 - 1.4. Application..... 4
 - 1.5. Drawings and Specifications..... 5
 - 1.6. Variations from Standards..... 6
 - 1.7. Permits..... 6
 - 1.8. New Service Areas 6
 - 1.9. Existing Service Areas 6
 - 1.10. Inspection..... 6

- 2. DESIGN 7**
 - 2.1. Sewage Flows..... 7
 - 2.2. Design Population..... 7
 - 2.3. Sewage Flow Calculation 8
 - 2.4. Sewage Characteristics 9
 - 2.5. Hydraulics 9
 - 2.6. Piping 10
 - 2.7. Pumping Stations..... 14

- 3. CONSTRUCTION..... 17**
 - 3.1. General 17
 - 3.2. Existing Structures and Utility Works 19
 - 3.3. Clearing..... 21
 - 3.4. Trench Alignment and Depth 21
 - 3.5. Trench Backfill..... 21
 - 3.6. Pipe Bedding 21
 - 3.7. Repairs 23
 - 3.8. Pipes and Fittings..... 23
 - 3.9. Manholes 25
 - 3.10. Service Boxes..... 27
 - 3.11. Service Connections 27

- 4. TESTING AND INSPECTION..... 27**
 - 4.1. Written Reports..... 27
 - 4.2. Materials Testing 27

4.3.	Leakage Testing of Gravity Sewers & Manholes.....	28
4.4.	Cleaning and Flushing.....	32
4.5.	Video Inspection of Sewer Mains.....	32
4.6.	Inspection.....	32
5.	<i>TRANSFERRING THE SEWER SYSTEM TO THE RDN</i>	32
5.1	Final Inspection by RDN.....	33
5.2	Preparation/Execution of Transfer Agreement by Developer.....	33
5.3	Preparation/Execution of Maintenance Agreement.....	33
5.4	Preparation/Execution of Latecomer Agreement.....	33
5.5	Letter of Acceptance of the Works by RDN.....	34

APPENDICES

Appendix 1.....	Standard Drawings
Appendix 2.....	Letter of Assurance
Appendix 3	Certificate of Design
Appendix 4.....	Certification of Installed Works
Appendix 5	Stand by Irrevocable Letter of Credit

1. GENERAL

1.1. *Requirement*

The RDN will require a “Subdivision Servicing Agreement” to be completed for any new sewer system or existing system extension, unless otherwise agreed to in writing by the RDN.

Sewage collection and conveyance systems shall be designed, installed, extended, tested and maintained in accordance with the following regulations and standards.

The sewer standards for design and construction of the sewer within the Lakes District and the Schooner Cove Community Sewer Standards Area are to be governed by Regional District of Nanaimo Land Use and Subdivision Bylaw No. 500, 1987, and particularly by this Schedule 4D1.

It is the intention of the RDN to enter into a phased development agreement under section 905.1 of the *Local Government Act* with the property owner of the lands within the Lakes District Comprehensive Development Zone CD44 and the Schooner Cove Comprehensive Development CD45 that will specify changes to specified subdivision servicing bylaw provisions that would not apply to the development contemplated under that agreement, unless agreed to in writing by the developer.

1.2. *Design*

The engineering design of the sewage collection and conveyance systems shall be carried out by, and the preparation of drawings and specifications shall be sealed by a Professional Civil Engineer registered in the Province of British Columbia, and shall conform to these Standards.

1.3. *Definitions*

ADWF means average Dry Weather Flow

AWWF means average Wet Weather Flow

B.O.D means quantity of oxygen utilized in the biochemical oxidation of organic matter under standard laboratory procedure in 5 days at 20°C expressed in mg/l.

Collection facility means A facility used for the collection and conveyance of sanitary sewage.

Comminuted Garbage means the wastes from the preparation, cooking and dispensing of food that have been shredded to such a degree that all particles will be carried freely under the flow conditions normally prevailing in public sewers, with no particle greater than 6mm in any dimension

Design Flow means peak sewage flow plus peak storm water infiltration.

Direct Service Area means land and improvements directly served by the proposed facility.

Engineer means the Manager of Engineering Services for the Regional District of Nanaimo, or the person designated by the General Manager of Regional and Community Utilities.

Engineer of Record means a Professional Engineer registered with the Association of Professional Engineers and Geoscientists of BC who is responsible for the construction drawings and documents. The Engineer of Record will be the engineer that signs and seals the record drawings and the certification of installed works.

Facilities means sewers, sewage treatment and disposal plants, pumping stations and other works necessary thereto, and outlets for carrying off, treating and disposing of sewage, and includes any and all works, structures, lands, conveniences, incidental to and necessary for a sewerage system.

Garbage means solid wastes from domestic and commercial preparation cooking and dispensing of food, and from the handling, storage and sale of produce.

Industrial Waste means liquid waste from industrial manufacturing processes trade or business, as distinct from sanitary sewage.

Lateral Sewer means sewer serving more than a single subdivided parcel

LPCPD means litres per capita per day

l/s means litres per second

mg/l means milligrams per litre

MPa means megapascals (1000 kPa)

Member Municipality or Member means a municipality or improvement district within the Regional District of Nanaimo.

M³/ha means cubic metres per hectare

M³pd means cubic metres per day

PDWF means Peak Dry Weather Flow

pH means the logarithm of the reciprocal of the weight of hydrogen ions in grams per litre of solution

ppm means parts per million

Peaking Factor (PF) means the Ratio of peak dry weather flow to the average dry weather flow.

Regional District means in this document the Regional District shall refer to the Regional District of Nanaimo.

Sanitary Sewage means sewage having a quality substantially equal to that of normal domestic sewage

Sanitary Sewer means a sewer which carries sewage and to which storm, surface and ground water are not intentionally admitted

Service Connection means a sewer connection a subdivided lot to the lateral sewer

Sewage Treatment Plant means an arrangement of structures and devices used for treating sewage

Stormwater Infiltration means the infiltration of groundwater or inflow of stormwater through leaks and connections into the system

Suspended Solids means solids that either float on the surface of, or are in suspension in water, sewage or other liquids, and which are removable by laboratory filtering

Tributary Area means all land in the service area tributary to the proposed facility

1.4. Application

All applications shall be made in the following steps:

1. Feasibility Review

All proposed construction of sewage collection and conveyance facilities shall be submitted to the Regional District for a feasibility review prior to commencement of any detailed design or construction. Such requests shall include a plan of the proposed construction and the area it will serve. The applicable feasibility review fee, in accordance with RDN Bylaw No. 1259.03 or most recent amendment, and the Letter of Assurance shall also be submitted at this time.

The Regional District will review the proposal, and reply in writing indicating the District's decision regarding acceptance or rejection, and/or the necessary amendments required.

2. Detailed Design

The detailed design and specifications shall be submitted in duplicate to the Regional District for Design Stage Approval (DSA) prior to construction. Attached to the submission shall be a Certification of Design. The applicable engineering review fee, in accordance with RDN Bylaw No. 1259.03 or most recent amendment, shall also be submitted at this time, along with the Design Professional Engineer's certified cost estimate for the works upon which the fee amount is based. *The final determination of the DSA fee shall be determined upon completion of the project and final certification of the construction costs by the Design Professional.*

The detailed plans will be returned either approved or with a request for re-submission. Re-submission will be carried out until the Regional District

approves the detailed plans and specifications, and issues Design Stage Approval (DSA).

The designer shall submit the RDN approved plans to the Provincial Ministry of Transportation & Infrastructure and Vancouver Island Health Authority for approval permits. Receipt and submission of these permits to the RDN shall also be a prerequisite to the start of construction. Approval permits from other applicable agencies as required shall also be obtained.

2.1. Drawings and Specifications

All design drawings shall be ISO A1 size, 594 mm in depth and 841 mm in width the following information shall be supplied

1. **Location Plan** - showing the location of the proposed work. This may appear on the same sheet as the Key Plan.
2. **Key Plan** - showing a plan of the proposed work at a suitable scale such that the whole works are shown on one drawing, usually 1:5000, 1:2000 or 1:1000. The Key Plan shall show a general outline of the works, area covered and sheet numbers of the plan/profile drawings, and a legend showing existing and proposed works.

3. **Plans/Profiles** - showing detailed design of the proposed works.

Plans shall be drawn at a scale of 1:500 or 1:250, showing the location of the pipe centre line, pipe size and type and off-set from property line, manholes, services, trench details, trench dam details and all related appurtenances in relation to road, easement and adjacent property and lot lines. Existing or proposed underground utilities are to be indicated on the plan in addition to the extent of work required in making connection to existing sewer main. Location of service connections are to be shown. Connections not conforming to the standard offset require a distance from an iron pin or lot line.

Profiles shall be drawn at a horizontal scale of 1:500 and a vertical scale of 1:50 if more suited to specific conditions. The profile shall show the line of the existing and finished road grade on centreline, the invert of the pipe, location of manholes, and location of storm and water utilities. Where vertical curves are used, the invert elevation shall be shown at the beginning and end of the curves.

4. **Specifications** - shall be prepared to further define materials of construction and shall specify methods of construction and workmanship.
5. **Record Drawings** - shall be prepared by correcting drawings on completion of construction in order to reflect "record drawing" conditions for permanent records. The location of all individual lot sewer service connections shall be clearly shown with distance from the nearest manhole to the service wye. The drawings shall be signed and sealed by the Professional Civil Engineer, and shall be

accompanied by a Certification of Installed Works. Final record drawings shall consist of:

- (a) Two (2) full-size paper sets;
- (b) One (1) full size 3 mil Mylar set;
- (c) 2 – 11" X 17" paper, sets or 2 A3 half-size paper sets, as agreed by the RDN; and
- (d) Digital copies: one (1) as AutoCAD or Civil 3D file as applicable to the current software, and one (1) as TIFF files.

1.6. Variations from Standards

Where the applicant wishes to vary from these standards he shall submit a written request with adequate supporting data to the Regional District for review.

The Regional District shall make the final decision in writing as to the standard requirements which shall apply.

1.7. Permits

The applicant shall be responsible for obtaining all necessary approvals and permits required prior to commencing construction of the sewer system.

1.8. New Service Areas

Where a sewer system is to be constructed by an applicant within an area previously unserved by a community sewer system, the design and construction for the system shall comply with the requirements of these standards, unless otherwise agreed to in writing by the Regional District.

1.9. Existing Service Areas

Where a sewer system is to be constructed by an applicant within the existing or extended boundaries of an area already being served by a community sewer system, the design and construction of the system shall comply with the requirements of these standards.

1.10. Inspection

The Manager of Engineering Services of the Regional District or his appointed deputies shall be allowed access and provided adequate facilities for access to any part of the works at all times for the purpose of inspection.

Any connections to or interruption of any existing system will only be permitted be under the direct supervision of the Regional District. Adequate notice to the Regional District of any such interruption to service shall be provided in order that attendance by Regional District personnel can be arranged.

Any connections to or interruption of any existing system will be under the direct supervision of the Regional District. Adequate notice to the Regional District of any such interruption to service shall be provided in order that attendance by Regional District personnel can be arranged.

2. DESIGN

2.1. Sewage Flows

Sanitary sewer systems shall be designed using the following formula to accommodate peak sewage flows and peak inflow & infiltration.

$$AWWF = PDWF + I\&I$$

Storm water connections shall not be made to the sanitary sewer system.

2.2. Design Population

Design contributory populations shall be calculated in accordance with the Regional District of Nanaimo’s population predictions or with the ultimate planned development in the tributary area, whichever is greater.

The following densities shall be used for housing types listed below:

Housing Unit	Persons per unit	Notes
Single Family / detached house	2.2	Based on 2011 census for Nanoose: 5674 persons / 2,587 housing units. Nanoose is predominately single family (>90% of dwellings)
Townhouse (attached, semi-detached) unit	1.9	Based on 2011 census for City of Nanaimo, City of Victoria
Apartment / condominium unit	1.4	Based on 2011 census for City of Nanaimo, City of Victoria
Secondary suite (carriage house)	1.1	50% of single family, consistent with draft zoning bylaw
Seniors living unit	1.1	Per CWPC Senior’s Housing Group

Where units are not known the following should be used:

- .1 Dwelling unit 30 pph
- .2 Multi dwelling unit development 125 pph
- .3 Commercial Equivalent of 50 pph
- .4 Industrial Equivalent of 50 pph
- .5 Institutional 50 pph

pph = persons per hectare

2.3. Sewage Flow Calculation

Average dry weather flow (ADWF) shall be established by multiplying the design population by an average daily sewage flow of 300 Litres per capita per day.

Peak dry weather flow (PDWF) shall be established by multiplying the ADWF by the peaking factor (PF) which obtained from the following formula.

$$PF=6.75*Population^{-0.11}$$

Peak dry weather flow can also be obtained using the graph contained in the standard drawing S-21.

For new developments, where water conservation measures are mandatory (such as low flow toilets), the sewage flow may be reduced by 10% from that obtained from this table.

Design sewage flows may be varied by the Regional District, where suitable metered flow record is available, or for developments utilizing wastewater (grey water) re-use onsite.

Peak inflow and infiltration (I&I) shall be calculated using:

- .1 12 m³/ha for Existing development areas
- .2 10 m³/ha for New development areas
- .3 The peak inflow and infiltration may be varied by the Regional District where suitable metered records for design storm events of maximum infiltration period of the year are available.

Design sewage rates of flow shall be computed by adding peak sewage flow to peak inflow and infiltration design allowances.

Sanitary sewage design calculations shall be prepared and submitted on a drawing showing the sanitary sewer tributary area as part of the detailed design drawings. If the sanitary sewer calculations are completed using modeling software the results of the software shall be displayed on the detailed design drawings. Use of modeling software shall be approved by the Regional District.

2.4. Sewage Characteristics

1. Sewage quality criteria shall be as follows:

Sewage Quantity (ADWF) in the Direct Service Area	Constituent	Average Normal
<50m ³ /day	BOD -5 day 20° C	1000mg/l
	Suspended Solids	800mg/l
	pH	4-10.5
	Temperature	79° C
50m ³ /day to 450 m ³ /day	BOD -5 day 20° C	400mg/l
	Suspended Solids	300mg/l
	pH	5-9.5
	Temperature	66° C
>450 m ³ /day	BOD -5 day 20° C	200mg/l
	Suspended Solids	200mg/l
	pH	5.5-9.0
	Temperature	54° C

2. Regulations governing the quality of wastes acceptable for admission to The Regional District of Nanaimo shall be followed and can be found in Bylaw 1225.

3. Where the existing industrial and/or commercial developments will be connected to the sewer system, the District may require that flow sampling be carried out to determine the design loadings; re-treatment of wastewater prior to discharge to the Regional District's facilities may be required.

2.5. Hydraulics

1. All facilities shall be designed to convey peak sewage flow plus peak I&I calculated as set out in section 2.3 sewage flow calculation.

2. Sewers shall be designed to carry the calculated design flow at a minimum velocity of 0.6 m/s.

3. When carrying design flow the maximum pipe depth of flow shall not exceed the following:

- | | | |
|-----|----------------|--------------------|
| (a) | <250mm | ¾ pipe diameter |
| (b) | 300mm to 450mm | ¾ pipe diameter |
| (c) | >500mm | Full pipe diameter |

4. Service connections shall be designed with a minimum velocity of 0.9m/s.

5. Force mains shall be designed with a minimum velocity of 0.6m/s.
6. Manning's Roughness Coefficient of 0.013 shall be used for design sewers and service connections. Manning's Roughness Coefficient of 0.015 shall be used for force mains and outfalls.
7. Manholes shall be designed to incorporate a minimum elevation differential of 30mm wherever a horizontal deflection exceeding 45 degrees occurs and 5mm where it is straight run. These elevation differentials are in addition to the normal grade of the lateral sewer.
8. Pumping stations and treatment disposal works shall be designed to process peak sewage flow plus peak I&I calculated as set out in section sewage flows section of these standards. Bypassing of works to disposal shall not be allowed except under emergency conditions.

2.6. Piping

1. Lateral Sewers

No lateral sewer shall be less than 200mm in diameter, unless the sewer is the final section of a lateral that cannot be extended, in that case, under the approval of the RDN a pipe 150mm in diameter may be used providing that it meets the hydraulic needs of the sanitary sewer.

2. Service connections

Service connections shall be minimum 100mm in diameter. Service connections serving more than one dwelling unit shall be minimum 150mm in diameter or sized in accordance with design flows and available grades.

No service connection shall exceed 15m in length measured horizontally between the lateral sewer and the property line without the approval of the Regional District. If a service greater than 15m is approved by the Regional District, a cleanout facility must be provided as shown on the standard detail drawing for service connection.

Water service and sewer services in a common trench shall be in accordance with the requirements of the Vancouver Island Health Authority.

3. Depths

Depths of all sewers shall be such that all basements in the area the sewer is intended to serve can be drained by gravity. Lift stations from individual homes will be acceptable as depicted generally in the Lakes District Infrastructure Phasing Drawing appended to this addendum. There may be other areas that will be serviced by individual lift stations subject to the Approval of the RDN.

Minimum cover on services shall be 0.75m.

Where minimum cover cannot be provided, an explanation of the reasons shall be submitted to the RDN with the proposed method of protecting the pipe.

Excessively deep service inspection assemblies should be avoided. Where standpipes are more than 1.8m in depth, the standpipes shall be constructed in two or more sections, each having a length not exceeding 1.8m.

4. Curved Sewers

Wherever possible, curved alignment shall be avoided.

Horizontal curves may be permitted where the configuration of the right of way permits curvature at a constant offset, where the velocity in the pipe exceeds 1m/s and where grades of 1% or greater are available. Tracer wire is required on all sewers with horizontal curves.

Vertical curves may be permitted where excessive depths or rock cuts are to be avoided or energy dissipation is needed.

Radius of curvature for PVC sewers to 250mm diameter shall be uniform throughout the curves by bending pipe barrel plus joint deflection to 2 degrees maximum and shall not be less than 60m or the manufacturer's minimum pipe radius, whichever provides a greater radius of curvature. PVC pipes 300mm diameter shall be deflected only at pipe joints to 2.5 degrees maximum, and 350mm diameter and larger pipes at pipe joints to 1.5 degree maximum. Miter bends are not to be used unless approved by the RDN.

Horizontal curves will be permitted for the gravity sewer along the eastern side of Enos Lake and in the park areas where sewers are approved. Curves radii are to be at or larger than manufacturers specifications. Vertical grades are to be chosen such that velocities must be equal to or exceed 1m/s (for max day flows at full build out).

Compound horizontal curves are not permitted between manholes.

Horizontal and vertical may be permitted in the same run.

Concrete pipe shall not be curved horizontally or vertically.

5. Manholes

In general the distance between manholes shall not exceed 150m, unless approved by the RDN. If approved by the RDN the maximum distance between manholes may be increased to 250m.

Manholes shall be located at grade and alignment changes, at lateral size changes, at the upstream end of all lateral sewers, at the junctions of all lateral, at regular spacing not exceeding the maximum allowable, sewers and at service connections larger than 150mm in size.

Cleanouts may be substituted for manholes at the upstream end of lateral sewers where no further extension of the sewer main is anticipated.

Where the difference between the incoming and outgoing invert exceeds 600mm, a drop manhole shall be used. See the standard detail drawings for drop manhole details. Differences between 150mm and 600mm should be avoided. Inside drop manholes with a minimum barrel size of 1200mm as shown in drawing the standard detail drawings, may be permitted for new construction of drops between 900mm and 2000mm and upon the approval of the RDN.

Manholes shall be constructed in a manner that prevents water from infiltrating into the manhole.

Where cast in place manholes are proposed, an explanation of the reasons shall be submitted to the RDN with the proposed design and construction method. Only ready mix concrete, 20 Mpa at 28 days shall be used.

Manholes shall be located so that the manhole covers are not located in the wheel paths of vehicles, in gutter lines, curbs or sidewalks.

Manholes located in untraveled areas shall have a 1m asphalt apron which slopes away from the manhole rims at 2%.

A watertight manhole frame and cover shall be required for all sewer manholes located in areas which flooding can occur.

Precast manhole bases shall be sized according to the following table

Pipe Size (mm) (Nominal)	Depth of Manhole (m) (Top of Cover to Inv.)	Barrel Size (mm) (Inside Diameter)
150-375	0 - 5.9	1050
150-375	6-9	1200
150-600	9 or deeper	1500
400-600	0-8.9	1200
675 – 1050	All depths	1500

6. Manhole Platforms

Manhole platforms are generally not required. Design of manholes shall consider use of appropriate safety equipment.

A cage, well or ladder safety device shall be provided where the length of climb is greater than 6 metres.

If platforms are necessary, ladders shall meet the following requirements:

- (a) The ladder shall consist of multiple sections.
- (b) Each section shall be horizontally offset from adjacent sections.
- (c) A landing platform shall be provided within the length of climb.
- (d) Refer to the Standard Drawings for manhole platform details.

7. Location of Sewers

Wherever possible, sewers shall be located on the high side of the street where only the high side is served by the lateral and on the low side of the street where both sides are served by the lateral. Wherever possible the sewer shall be located on the opposite side from the watermain and at a constant offset from the property line or paved roadway.

Sanitary lateral sewers shall be located at least 3.0m horizontally and 0.45m vertically from water pipes unless approved by the Vancouver Island Health Authority and all joints are suitably coated and wrapped.

Sanitary sewer mains may be installed in a common trench with storm sewers provided the minimum outside pipe separation is 300mm.

8. Utilities in Private Lands

The design of utilities shall avoid crossing private lands as much as possible.

Utilities crossing private lands shall generally be offset a minimum 1.5 metres from the property boundary unless otherwise approved by the Regional District.

Appurtenances such as manholes, valves ect. shall not be located on property boundaries.

Utilities shall not cross private lands in such a manner that they render the property unusable and generally be located beyond the normal building envelope allowed by zoning. Special considerations must be given to ensure the location of the utility crossing minimizes the limitation on the future use of the property.

The minimum width of the right of way shall be 3m for single pipes and 4.5m for two pipes installed in a common trench.

9. Siphons

Where a siphon (i.e. inverted sewer, depressed sewer) is required to carry flow under an obstruction such as a stream, the following criteria shall be applied to the design:

- (a) All siphons shall be multiple pipe structures.
- (b) A cleansing velocity of 0.6 to 0.9 m/s shall be reached at least once a day in the primary pipe even during the first years of operation.
- (c) The total system shall be sized to accommodate the ultimate design peak flow.
- (d) A 1200mm diameter manhole shall be provided on both ends of the siphon.
- (e) Each manhole on the siphon shall be provided on both ends of the siphon.
- (f) There shall be no high points in the siphon between manholes.
- (g) There shall be no acute bends in the siphon.
- (h) There shall be no change of pipe diameter between manholes.
- (i) The primary pipe shall be minimum 200mm in diameter wherever possible.
- (j) All siphons shall have a separate debris sump manhole upstream of the siphon. The debris sump shall be designed to allow easy access for maintenance and cleaning and shall be suitably vented.

2.7. Pumping Stations

This section applies to all municipal owned and operated sanitary sewer pumping stations. Properties serviced by individual sewer pumps shall be connected to the municipal sewer system by a gravity service connection from the property line to the municipal sewer system.

This section is intended as a guide for general requirements for a pumping station. All pumping station designs shall be developed using good engineering practice with the input of the Regional District of Nanaimo.

Sanitary sewer pump stations shall only be permitted at locations where gravity connections from an existing or proposed trunk sewer cannot be provided.

1. General Design Criteria

Pump station size and configuration shall accommodate ultimate sewage flows.

Pumping stations shall be designed and constructed using materials recognized for quality in the sanitary sewer industry.

Pumping stations shall be fully automatic in normal operation, and fully compatible with the Regional District of Nanaimo's telemetry system. Specifics of SCADA systems shall be coordinated with the Regional District of Nanaimo during the pre-design stage.

All stations shall have a wet well capacity providing not more than 12 hours of storage at minimum design flows and a frequency of pump start –up of not less than 5 minutes at peak flows.

No overflow of sewage shall be permitted. Pumping stations shall have emergency backup systems to prevent sewage overflows during a mechanical or electrical failure.

4 complete (3 paper and 1 digital) sets of operational instructions, maintenance manuals, emergency procedures, parts lists, as-built engineering drawings, shall be submitted to the Regional District of Nanaimo upon completion of the pump station.

Current and future service requirements shall be evaluated with the electrical and phone utility companies.

Buildings shall have gutters on all four sides of the roof.

Pump station buildings shall be BC Hydro green in colour.

2. Pumps and Equipment

As a minimum, pumping stations shall be equipped with alternating duplex pumping units. One pump shall be equipped with a flush valve.

Duplex pump arrangements shall be designed for each pump providing 100 percent standby at peak flow.

Individual pump motors shall be equipped with hour meters and pump run indicator lights.

All pumping units to be grinder or vortex pumps capable of handling a 75mm solid, without clogging.

All piping and valves shall have a minimum of 100mm diameter.

Minimum pump run time shall not be less than 2.5 minutes or as recommended by pump manufacturer; whichever is greater.

Each sewer pump shall be provided with its own individual pipe connection to the wet well.

A concentric increaser shall be provided on the pump discharge followed by a check and gate valve.

Check valves on discharge lines shall be ball type.

The desirable velocity at the discharge point at maximum pump discharge is from 1.8 to 2.5 metres per second.

3. Controls

Stations shall be equipped with high and low level alarm, security alarm, power fail alarm and general alarm (for motor overload, temperature, and moisture alarms if so equipped.) Also, a level transducer probe and data logger, suitable to the Regional District, shall be installed in the wet well.

Manual operation of all pumps by push-button control shall be possible for checking the operation and for drawing down the wet well. Manual operation shall bypass the low water cutout but not the low water alarm.

Wiring for the control panel shall be underground from the hydro pole to the control panel kiosk.

Alarms shall have audio & visual alerts at the pumpstation.

Stations with submersible pumps shall have the motor starters and controls located in a factory assembled free-standing unit control centre located at ground level on a concrete pad.

Stations with non-submersible pumps, shall have the pump motors and controls located in a ventilated, heated, lighted and dehumidified area.

Name plates, approved by the Regional District, shall be supplied on the pump's control enclosure components and other operating components to indicate to the operator the purpose of the component or the operating routine applying to the component.

An isolation switch for each pump shall be located within sight of a service man working inside. Switches shall function by breaking the pump control circuit, thereby isolating the main power at the control panel.

Relays are to be used in conjunction with level controls.

An electrical panel heater and thermostat shall be installed inside all control panels.

The control panel kiosk shall be aluminum.

The control panel shall include an extra 110 volt, 10 amp, duplex receptacle, complete with cover, for operation of small electric tools. It shall be separately fused within the control panel.

4. Standby Power

The onsite provision of a standby power generator will be decided on a site specific basis by the Regional District . If the Regional District decides that permanent standby power facilities are not needed for the specific pump station, the pump station shall be equipped with a generator receptacle matching the Regional District style.

5. Pumping Station Chamber

The control panel and non-submersible pump motors shall be located in one above-ground enclosure unless otherwise approved by the Regional District.

The below grade chamber shall be reinforced concrete construction or as approved by the Regional District.

Concrete pump chambers shall have a 1 to 1 slope benching around the base perimeter.

Exterior concrete walls shall be tar-coated to prevent leakage.

The chamber above grade shall be designed to harmonize with the surroundings, shall be of fireproof construction and have no windows.

Chamber access shall be in accordance with the latest WorkSafe BC Regulations.

Equipment guards and rails for floor openings shall be provided.

Independent mechanical ventilation shall be provided by explosion proof exhaust fans for the dry and wet chambers where applicable. If the ventilation system is intermittent rather than continuous, the electrical switches shall be interconnected with the station lighting system. Ventilation interconnected with the station lighting system shall have sufficient capacity to exchange the total volume of air inside the station with fresh air within 3 minutes. All vents lines shall have screened openings to prevent the entrance of rock or other foreign matter. Air flow in fans shall be fresh air to wet well with second vent out for discharge.

Dry well stations shall include a sump and sump pump for the interior of the dry well with discharge above the top water line in the wet well.

The entrance to the station shall be waterproof and supplied with a lockable door complete with security alarm.

Where the entire station is underground, the entrance shall not be more than one metre above the surrounding finished grade.

6. Sitework and Lighting

A 25mm water service connection, complete with an approved backflow prevention device, shall be provided in the station designed in accordance with the AWWA Cross-Connection Control Manual.

The pumping station and appurtenances shall be within a porous paved surface or approved gravel which provides for the turning movements. A minimum turning grade of 12.8 metres, shall be used to determine turning movements. A minimum of 3.65 metres in width is required for access to all equipment. Approved landscape screening shall be provided.

Storm drainage from the site shall be self-contained.

Adequate protection shall be provided to prevent vandalism and vehicular damage and to protect public safety. Requirements may include fencing, non-mountable curbs and/or traffic bollards.

High pressure sodium, dark sky compliant, lighting shall be provided unless otherwise approved by the Regional District. Backup lighting connected to the standby power supply shall be provided in case of a power failure.

7. Force mains

All force mains shall be designed so that the minimum velocity is 0.6m/s and a detention time not exceeding 12 hours during ADWF.

Force mains shall be designed without high points unless otherwise approved by the RDN. If approved, an air-relief valve shall be provided at high points in the line, meeting RDN requirements.

Thrust blocks shall be provided at all bends as required.

Cleanouts (blowdowns) shall be supplied at all low points of force main.

Flushouts shall be located at the terminus end of all pressure sewer mains leading to manholes or pump stations.

3. CONSTRUCTION

3.1. General

1. Access Roads

Temporary roads shall be constructed as required for access to the working areas. Adequate drainage facilities in the form of ditches, culverts, or other conduits shall be installed as found necessary to maintain these roads. In the construction of access roads, existing drainage facilities, natural or otherwise, shall not be disturbed to the detriment of properties outside the working area and such facilities shall, unless otherwise provided elsewhere in the specifications, be restored to their original condition on completion of the work.

2. Sanitary Facilities

Clean, sanitary latrine accommodations shall be provided and shall be located and maintained in accordance with the regulations of VIHA.

3. Special Tools, Operating Manuals, Shop Drawings

With each piece of mechanical and electrical equipment or machinery having wearing parts and requiring periodical repair and adjustment, all special tools, wrenches, and accessories required for removing worn part, making adjustments, and carrying out maintenance shall be supplied. All gauges, indicators, and lubricating devices necessary for the proper operation of the equipment shall be furnished.

With each piece of equipment, 4 sets of operating manuals and as-constructed shop drawings shall be supplied. The manuals shall provide the manufacturer's recommended maintenance schedules with the grades of lubricants required, and instructions as to how the equipment may be taken apart for periodical inspection and replacement.

4. Blasting

Blasting will be permitted only after securing the approval of the applicable authorities. Blasting will not be carried out without first verifying that insurance covers any loss of life or damage that may result from this work. The Regional District, in granting approval for blasting, does not in any way assume responsibility for injury, loss of life, or damage that result there from, and such approval shall not be construed as approval of the methods employed in blasting, the sole responsibility therefore being that of the applicant.

5. Site Maintenance and Clean Up

The working area shall be maintained in an orderly manner and shall not be encumbered with equipment, materials, or debris.

Clean up shall be a continuing process from the start of the work to final acceptance of the project. Property on which work is in progress shall at all times be kept free from accumulations of waste materials or rubbish. Accumulations of waste materials, which might constitute a fire hazard, shall not be permitted. Spillage from hauling vehicles on traveled public or private roads shall be promptly cleaned up. On completion of construction, all temporary structures, rubbish, and waste materials resulting from the operations, shall be removed.

6. Erosion and Sediment Control

An Erosion and Sediment Control Plan shall be submitted for review and approval seven days prior to the pre-construction meeting. The Erosion and Sediment Control Plan shall describe the proposed methodology to minimize potential impact on the surrounding environment. The Erosion and Sediment Control Plan shall indicate how the Contractor plans to control sediment discharges from the project and what measures will be put in place to prevent damage to aquatic habitat located downstream.

The work shall be carried in compliance with the submitted and approved Erosion and Sediment Control Plan and all other environmental laws affecting the work and with the recommendations contained in the most recent edition of the “Land and Development guidelines for the Protection of Aquatic Habitat” published jointly by the Ministry of Land, Water, and Air Protection and Fisheries and Oceans Canada.

For the erosion and sediment control plan, ‘environmental laws’ means all statutes, regulations, orders, and bylaws relating in any way to the natural environment or its ecosystems, public or occupational health, transportation, storage or handling of contaminants or hazardous materials.

3.2. Existing Structures and Utility Works

1. Scope

Existing structures shall be interpreted as being all existing pipes, ducts, ditches, or other works forming a part of sewerage, drainage, water, telephone, electrical, gas, or other utility system, as well as sidewalks, curbs, poles, fences, buildings, and other man-made things that may be encountered during construction.

2. Material Supply

Unless otherwise specified, materials supplied for replacement of existing structures shall be at least equal to those being replaced.

3. Location of Structures

Drawings or descriptions, verbal or otherwise, of existing structures or their location that are supplied by the Regional District are intended only as an aid to locating these structures. Measurements and location of the existing underground structures shown on the drawings are not guaranteed to be accurate, and must be verified prior to proceeding with construction.

4. Protection of Structures

Unless authorization from the Regional District is received for their removal, underground and surface structures encountered during construction shall be protected from damage. In the event of damage resulting from the construction operation, structures shall be repaired or replaced to a condition, which is at least the equivalent of that which existed prior to construction.

5. Emergency Situations

In emergency situations resulting from the construction operation, where life or property are endangered, the applicant shall immediately take whatever action is possible to eliminate the danger, and shall also notify the Regional District of the situation.

6. Access Maintained

Existing hydrants, valves or control pit covers, valve boxes, curb stop boxes, fire or police call boxes, and all other utility controls, warning systems, and appurtenances thereof shall not be made inaccessible at any time by the construction work. Bridges, walks, or other temporary facilities shall be provided as may be necessary to ensure that these controls or warning systems are free for use in their normal manner at all times during construction.

7. Curtailment of Utility Service

Where existing utilities such as water, sewer, electricity, telephone, and gas are serving the public, work shall be planned and executed such that there is no curtailment of service provided by these utilities without prior receipt of approval of the authorities responsible for provision and maintenance of these utilities. The applicant shall obtain the above approvals from the recognized authorities controlling these utilities. If approval for such disruption of utility service is not granted, it may be possible to establish temporary facilities to provide continuous utility service during the course of construction. Such temporary facilities shall only be implemented after receiving the approval of the utility authority.

If approval is received to temporarily shut off an existing utility, individual users of the utility shall be notified at least one hour prior to the time of shut-off.

8. Support of Structures

Existing structures shall be protected against damage from settlement by means of timber support or compaction of backfill as required. Where necessary, timber support shall remain in place following backfill of excavations.

Backfill which is placed under or adjacent to the existing structures, which have been undermined during excavation, shall be compacted in a manner which will prevent damage of the structure from settlement. Such backfill shall be of approved granular material suitable for compaction.

On existing piping, this material shall extend horizontally a minimum distance of 600 mm on both sides of the pipe at a level 300 mm above the pipe, and shall slope down from this point at 1-1/2 horizontal to 1 vertical to meet the bottom of the excavation.

9. Drainage Facilities

Existing culverts, enclosed drains, flumes and ditches, and other drainage structures affected by the work but left in place shall be kept clear of excavated material at all times during construction. When it is necessary to temporarily remove an existing drainage structure, suitable temporary ditches or other approved means of handling the drainage shall be provided during construction.

3.3. Clearing

Prior to clearing, the exact limits of the areas on which clearing may take place and whether or not there are restrictions placed on clearing which would result in leaving certain trees, structures, or other existing items in place shall be ascertained.

Prior to trenching, the right-of-way shall be cleared of all standing or fallen brush, timber, stumps, or other debris, which may obstruct the construction operation, damage the completed installation, or detract from the appearance of the site on completion of construction. This material shall be burned or otherwise disposed of to the satisfaction of the Regional District.

The restrictions of all authorities established to control burning in the area shall be complied with. If burning cannot be done on the clearing site, the material shall be hauled to an approved location for burning or disposal. Burning permits, as required, shall be obtained by the applicant.

3.4. Trench Alignment and Depth

Following clearing and prior to excavation of the trench, the location at which the pipe shall be installed shall be established by setting appropriate survey control. As a minimum this shall include marking of the manholes and any horizontal or vertical curves in the pipe, with suitable elevation data provided. A laser should typically be used to maintain grade during pipelaying, and for all grades of 2% or less.

Where pipe is to be installed to a predetermined grade, a cut sheet will be provided showing the depth of the pipe invert relative to the grade stake elevation at the respective locations along the pipeline.

The trench shall be excavated so that pipe can be laid to the established alignment and depth, with allowance made for specified trench wall clearances and bedding as shown in the standard drawings of this Schedule for various conditions, or otherwise required.

All trenching and excavations shall be carried out in the manner recommended by the Workers' Compensation Board of British Columbia, or as may be necessary to protect life, property, and structures adjacent to the work and the work itself.

3.5. Trench Backfill

Trench backfill shall be carried out as shown in the standard drawings of this Schedule for various conditions.

3.6. Pipe Bedding

1. Granular material for pipe bedding within the pipe zone shall be sand or clean gravel or crushed rock, evenly graded from coarse to fine, and conforming the following specifications and gradations limits:
2. The standard trench section is shown in the standard drawings of this Schedule for various conditions. The nominal minimum depth of cover shall be 1.5 m in traveled areas and 1.0 m in untraveled areas unless otherwise permitted by the Regional District. Water mains shall be located not less than 3 m centre-to-centre from all sanitary lines, unless otherwise permitted by the Regional District and the Vancouver Island Health Authority.

3. Bedding material shall conform to the following gradation limits:

Gradation Limits

(Percent by Weight Passing)

<u>Sieve Designation</u>	<u>Type 1</u>	<u>Type 2</u>
19.0 mm	100	90-100
12.5 mm		65-85
9.5 mm	85-100	50-75
4.750 mm	70-100	25-50
2.36 mm		10-35
1.18 mm	20-65	
0.850 mm		5-20
0.6 mm	0-45	
0.425 mm		0-15
0.18 mm		0-8
0.15 mm	0-10	
0.075 mm	0-5	0-5

4. Type 1 is the standard acceptable bedding material. Type 2 shall be used where specified by the design engineer to meet special design loading. Dry sieve analysis shall be carried out in checking material gradation.
5. Other acceptable bedding materials, for use only where shown on the construction drawings or as approved by the Engineer, are drain rock, pea gravel or native material. In rock, pipe zone shall have filter fabric between rock and bedding material. Filter fabric shall be non-woven, minimum grade Armtec 200 or equivalent.
6. The bedding material shall cover the full width of the trench bottom and have a minimum depth of 100 mm on completion of compaction. In rock excavation the minimum depth of bedding below the pipe shall be 150 mm after completion of compaction.
7. Bedding material shall be compacted in maximum 150 mm lifts to 95% of Modified Proctor Density (ASTM D1557). Side tamping shall be carried out with bedding material placed to the pipe springline, to provide haunch support.
8. Bedding material shall be placed in such a manner that the pipe is evenly supported throughout its length by the pipe bedding material.
9. Placement and compaction of the bedding material shall not damage or displace the pipe.
10. Bedding material shall be leveled across the full width of the trench to an elevation of 300 mm above the crown of the pipe.

3.7. Repairs

Any system approved and built to these standards which requires maintenance work, shall be repaired with materials and construction methods conforming to the specifications contained herein.

3.8. Pipes and Fittings

The size and type of the pipe to be used are to be shown on the design drawings.

Only the pipe types listed in this section shall be used for lateral sanitary sewers or services.

Pipe shall be installed in strict accordance with all of the manufacturer's recommended practice.

All products used shall conform to the Regional District of Nanaimo's Approved Product List.

1. Polyvinyl Chloride (PVC) Pipe, Lateral Sewers

- (a) PVC pipe shall be DR 35.
- (b) Pipe and fittings shall be manufactured to the following standards:
 - 100mm to 375mm ASTM D3034 and CSA B182.2
 - 450mm to 675mm ASTM F679 and CSA B182.2
- (c) All PVC sanitary gravity main pipes should be green in colour.
- (d) Sanitary sewer main pipe, fittings and service connections shall be joined with a rubber gasket or other preformed, factory manufactured gasket or approved material designed for use with the specified pipe. Solvent connected joints and fittings will not be permitted.

2. Polyvinyl Chloride (PVC) Pipe, Service Pipes & Fittings

- (a) PVC pipe of 100 mm pipe diameter shall be DR 28.
- (b) Services larger than 100mm shall be as specified the same as lateral sewers.
- (c) All sanitary services 100mm in diameter shall be white.
- (d) Service connections to be PVC mainline pipe shall be made with PVC fittings manufactured to ASTM D3034, CSA 182.1 and CSA 182.2.
- (e) The use of saddles instead of manufactured wye fittings shall require approval of the RDN.

3. Polyvinyl Chloride (PVC) Pipe, Pressure Pipe

- (a) Pipe shall be white in colour.
- (b) Pipe and fittings shall be manufactured to the following standards:
 - 100mm to 300mm AWWA C900 and CSA B137.3
 - 350mm to 900mm AWWA C905 and CSA B137.3
- (c) Pipe shall be compatible with mechanical and push-on joint fittings and valves without the use of special adapters.

- (d) Pipe shall include push-on integrally thickened bell and spigot type joints conforming to ASTM D313.9 with single elastomeric gasket conforming to ASTM F477.

4. High Density Polyethylene (HDPE) Pipe (Smooth Profile)

- (a) Pipe shall conform to CGSB 41-GP-25M. Pipe material shall conform to ASTM D1248 Type III, Class C, Category 5, Grade PE 35-10
- (b) Minimum Acceptable pipe class shall be DR 26 with a hydrostatic design stress of 10MPa.
- (c) HDPE pipe used for pressurised applications shall be a minimum pipe class of DR21.
- (d) All pipe shall bear the pipe series designation and manufacturers name.
- (e) Fittings for HDPE, if required, shall be detailed and manufactured by the pipe manufacturer. Mitre bends shall be fibreglass reinforced. Fittings shall have a pressure rating at least equal to that of the pipe it is being joined.
- (f) Pipe may be deflected up to the manufacturer's recommended minimum radius. Deflected pipe may be used instead of manufactured or mitred bends.
- (g) Joints shall be by thermal butt-fusion and constructed in accordance with the manufacturers specifications.
- (h) Flange joints shall be used to join long sections of butt joined pipe or as shown on the design drawings.
- (i) Flanges for HDPE pipe shall be slip-on type installed in conjunction with stub ends supplied by the pipe manufacturer. The flanges shall be class 150 meeting ANSI B16.5 drilling dimensions. Flanges shall be carbon steel.
- (j) All flanged joints shall be separated by a neoprene gasket bonded to one of the flange faces. Neoprene for flange gaskets shall be 3mm thick with holes drilled for flange bolts and size equal to flange diameter.
- (k) Bolts and nuts for flanges shall be hot dipped galvanized.
- (l) HDPE pipe shall only be used where approved by the RDN.

5. Concrete Pipes

- (a) Concrete pipe should only be used for sewer mains larger than 450mm in diameter.
- (b) Concrete pipe should be reinforced, ASTM C 76 Specification.
- (c) Lifting holes in concrete pipe shall be plugged with prefabricated plugs in non-shrink grout or other plugs recommended by the pipe manufacturer.
- (d) Concrete pipes shall have every joint grouted.
- (e) Testing for concrete pipes shall be carried out hydraulically. Air testing will not be permitted.

6. Ductile Iron Pipes (DI)

- (a) Ductile iron pipe may be used with the specific approval of the Regional District.
- (b) Soil corrosion survey will be required, and suitable corrosion protection measures installed.
- (c) Testing for ductile iron pipes shall be carried out hydraulically. Air testing will not be permitted.

3.9. Manholes

1. Manhole Sections

- (a) Unless otherwise approved, all manhole sections shall be precast reinforced concrete in accordance with ASTM C478.
- (b) All precast sections shall be complete with ladder rungs as the manhole steps section listed below.
- (c) O-ring rubber gaskets shall be placed between Manhole sections. The O-ring rubber gaskets shall conform to ASTM C443.
- (d) The inside surface of the precast barrel at the O-ring joints shall be filled with cement grout to a smooth finish.
- (e) Precast manhole barrel sections shall be placed plumb.

2. Manhole Bases

- (a) All manhole bases are to be precast unless otherwise approved.
- (b) Manholes bases shall be constructed so that the first section of a precast base can be set plumb with a uniform bearing pressure throughout its circumference.
- (c) Precast manhole bases shall be placed on 150mm thick base of 40mm drain rock.
- (d) Precast manholes and Cast-in-place manhole bases shall conform to the applicable standard drawings.
- (e) Cast in place manholes or connections to existing manholes shall utilize a rubber adaptor ring to seal the connection.
- (f) If the material at the bottom of the trench is unsuitable for support, the bottom shall be over excavated to a firm base, and backfilled with base gravel and thoroughly compacted.

3. Manhole Tops

Manhole tops shall be flat slab, precast concrete. Tops shall be reinforced to meet H20 loading conditions. Precast tops shall conform to ASTM C478 with approved offset opening for frame and cover.

4. Manhole Covers and Frames

- (a) Covers and frames shall be cast iron and certified to meet H20 loading requirements.
- (b) Covers and frames shall conform to the standard drawings.

- (c) Covers shall have “RDN SANITARY SEWER” permanently embossed on the cover.
- (d) Utility chamber manhole frame and cover shall conform to the standard drawings.
- (e) A watertight manhole frame and cover, if required shall conform to the standard drawings.
- (f) Covers located in statutory rights-of-way shall be permanently embossed with the additional wording “DO NOT COVER”.
- (g) Frames shall be set on precast concrete grade rings to bring the cast iron manhole frame to grade as shown on the drawings.
- (h) In unpaved areas, covers shall have a 1m circular 50mm thick asphalt apron sloping away from the manhole cover at a minimum grade of 2%.
- (i) In paved areas covers shall not protrude above the finished pavement.
- (j) In streets manhole covers shall not be placed in the wheel paths of vehicles.

5. Manhole Steps

- (a) Steps shall conform to ASTM C478 for manhole steps, they shall be 19mm either hot dipped galvanized cold rolled steel or aluminum alloy.
- (b) All steps shall be complete with approved polyethylene anchor insulating sleeves and installed in 25mm to 26 mm precast drilled holes in a manhole section.
- (c) Distance between manholes steps shall be maximum 400 mm, with the first manhole step being a maximum 500mm from top of the manhole. Manhole steps shall conform with the most up to date Worksafe BC’s standard *G13.2(1)(b) Ladders in manholes*.
- (d) Manhole steps shall be installed 75mm into the manhole section wall.

6. Manhole Platforms

- (a) Manhole platforms are generally not required. Design of manholes shall consider use of appropriate safety equipment.
- (b) A cage, well or ladder safety device shall be provided where the length of climb is greater than 6 metres.
- (c) If platforms are necessary, ladders shall meet the following requirements:
 - The ladder shall consist of multiple sections.
 - Each section shall be horizontally offset from adjacent sections.
 - A landing platform shall be provided within the length of climb.
 - Refer to the standard drawings for additional details.

7. Concrete for Manholes

- (a) The compressive strength of concrete used shall not be less than 20 MPa at 28 days.

- (b) All concrete shall contain an air entrainment agent to provide 4% to 6% air content.

3.10. Service Boxes

Service boxes for sanitary services shall be 305 mm x 508 mm Concrete boxes complete with cast iron lid. The lettering shall read "SEWER".

Service boxes shall not be installed, they shall be supplied to the Regional District of Nanaimo's works yard.

3.11. Service Connections

Service connection piping shall be as detailed elsewhere in this standard.

Each service shall have its own independent connection into the main sewer.

Service connections shall have a minimum grade of 2% unless otherwise directed by the Engineer.

Services shall be constructed in accordance with the standard drawings.

Minimum cover for services shall be 0.75m at property line.

In rock, the trench is to be excavated minimum 1m into the property.

Approved watertight caps suitably supported by sandbags to prevent leakage shall be installed on sewer services at the terminus of each service.

A 50 mm x 100 mm wood marker stake shall be placed at the end of the service connection. The stake shall be painted red with the depth to invert of service to the nearest 0.01m marked. The wood marker stake shall be a minimum 3m from the service box

4. TESTING AND INSPECTION

4.1. Written Reports

The applicant shall submit reports to the Regional District certified by a Professional Engineer of the tests and requirements specified herein.

4.2. Materials Testing

If, in the opinion of the Engineer, testing is required, the Engineer will arrange for a testing firm to carry out tests to determine whether the applicable standards and specifications have been met. Where initial testing indicates inadequacies additional testing may be required by the engineer.

The Contractor as directed by the engineer shall supply specimens or samples for testing.

The types of tests listed below may be required by the engineer unless in the opinion of the Engineer other testing is required.

Joints for sanitary sewer main pipe and fittings and service connection pipe fittings shall be capable of meeting the following exfiltration tests. The Engineer may require that

these tests be carried out by the contractor or his supplier prior to the acceptance of pipe on the project.

(a) Pipes in Proper Alignment:

Not fewer than 3, or more than 5, pipes selected from stock by the Engineer shall be assembled according to standard installation instructions issued by the manufacturer. With ends bulkheaded and restrained against internal pressure, the section shall be subjected to 70 kPa hydrostatic pressure. Pressure shall be maintained for a period of 24 hours. There shall be no leakage at the joints.

(b) Pipes in Maximum Deflected Position:

At least 2 of the joints of the assembly shall be deflected to the maximum amount recommended by the manufacturer. 35 kPa internal hydrostatic pressure shall then be applied to the test section and maintained for a period of 24 hours. Joints shall show no leakage.

(c) Pipes in Maximum Lateral Misalignment:

The test section shall be supported on blocks or otherwise so that one of the pipes is suspended freely between adjacent pipes and bears only on the jointing material. The suspended pipe shall then be loaded on the bell or coupling by a load equal to one-third of the ultimate 3-edge bearing strength required by the applicable ASTM specification, except that pipe having a laying length of more than 1.2 m shall be loaded no more than the amount computed for a 1.2 m length. While under this load, stressed joints shall show no leakage under 35 kPa internal hydrostatic pressure.

4.3. Leakage Testing of Gravity Sewers & Manholes

Leakage test shall be performed by the contractor on all sanitary sewers and service connections, manholes and appurtenances

1. Type of Test:

- (a) Leakage testing on gravity sewers shall be tested with low pressure compressed air.
- (b) Leakage tests on concrete, ductile iron and HDPE gravity sewers shall be ex-filtration water tests.
- (c) Leakage tests on manholes shall be ex-filtration water tests
- (d) Testing shall only be carried out after the pipe has been backfilled, and only on completed sections between manholes.
- (e) All test results to be witnessed by the Engineer or the Engineer's Representative.

2. Testing Equipment:

The Contractor shall furnish all the necessary testing equipment, including suitable removable watertight plugs and test balls and shall perform the tests in

a manner satisfactory to the Engineer. Testing equipment must provide readily observable and reasonable accurate measurements of leakage under the specified conditions. The Contractor must comply with all Worksafe BC regulations covering the use of air testing, and ensure that safe working practices are used in the application of the test.

3. Leakage Testing with Water:

Ex-filtration Testing:

On an exfiltration test, the test section shall be sealed at the lower extremity by means of a watertight plug. The test section shall be filled with water such that a minimum hydrostatic head of 600 mm minimum head shall be maintained for a period of not less than one hour, and unless excess exfiltration requires further testing, not greater than 8 hours. Pressures in excess of 3 metres water are not recommended. Damage resulting to pipe as a result of testing shall be repaired by the Contractor at his own expense.

Manholes shall be tested for leakage by filling the chamber to the underside of the roof slab with water. Water level shall be rechecked following a minimum time period of four hours. No leakage shall be permitted in manholes.

In areas where the groundwater table is above the sewer invert level, the test shall be increased by a height equal to the distance from the sewer invert level to the water table elevations.

Ex-filtration test sections shall normally have a manhole at both extremities. If, however, sewer grades are such that a test section cannot be terminated at a manhole without placing excess pressure on the pipe or joints, apparatus shall be provided to enable testing without having manholes at the upper and lower ends of a test section.

Gravity sewers, service connections appurtenant structures thereon shall be constructed such that leakage, as evidenced by exfiltration tests, is less than that calculated using the following formula:

$$\text{Allowable leakage in litres} = \frac{\text{HDL}}{5200}$$

Where: H = duration of test in hours,
D = inside diameter of the pipe in millimetres, and
L = length of pipe in the test section in metres

The above leakage limit will constitute the total maximum allowable leakage of any test section of gravity sewer. Where service connections exist along the test section, the allowable leakage from service pipe calculated by the use of the above formula will be added to that of the main sewer to arrive at the total allowable leakage unless the elevation of the service connection pipe is greater than the maximum water elevation. No additional leakage allowance will be made for manholes existing along the test section.

The maximum allowable leakage for an ex-filtration test will be that calculated by the above formula regardless of the test head of water employed. Where a section of sewer is found to have leakage exceeding the allowable limit, replacement or repairs shall be made to reduce the amount of leakage to or below the allowable limit. Repaired sections shall be retested until they meet the allowable limit.

All point sources of leakage discovered during the leakage testing shall be made watertight by the Contractor to the satisfaction of the Engineer.

The Contractor shall dispose of the water used for testing in a manner approved by the Engineer.

4. Leakage Testing With Air:

On an air test, the section to be tested shall be plugged at each end and all service laterals, stubs and fittings properly capped or plugged.

Air shall be supplied to the test section slowly, filling the line to a constant pressure of 24.0 kilopascals (kPa). The air pressure inside the pipe shall not exceed 27.5 kPa except in the case where the groundwater level is above the sewer line being tested. In the event of the groundwater level being above the invert, the air test pressure must be increased by 1.0 kPa for each 100 mm of groundwater above the invert.

The air supply is throttled to maintain the internal pressure above 20.75 kPa for a minimum of 5 minutes to stabilize the temperature in the pipe. After stabilization, the air pressure is adjusted to 24.0 kPa, timing commences and the time required for the line pressure to drop to 17.25 kPa is noted.

If the time required to drop from 20.75 to 17.25 kPa is greater than allowable, the test section shall have passed.

For the air test the minimum time allowable is calculated from the following tables:

Time Requirements for Air Testing

PIPE SIZE (Millimetres)	TIME	
	Min.	Sec.
100	02	32
150	03	50
200	05	06
250	06	22
300	07	39

PIPE SIZE	TIME
-----------	------

(Millimetres)	Min.	Sec.
375	09	35
450	11	34
525	13	30
600	15	24

Where various pipe sizes are to undergo the air test, the average size shall be used.

5. Testing of Force mains

Following final trench backfilling, leakage tests shall be performed on all installed piping.

Leakage tests shall be carried out between valved sections of the installation such that every valve in the system is tested for leakage in the shut-off position.

Leakage tests shall be performed in the following manner. The section to be tested shall be filled with water and all air expelled from the piping. It is recommended that the test section be filled with water for at least 24 hours prior to testing. By pumping water into the test section, the pressure within the piping shall be increased to 0.7 MPa, or 1-1/2 times the system operating pressure at the point of test, whichever is the greater. This pressure shall be maintained constantly in the pipe throughout the duration of the test by the addition of make-up water. The duration of the test section to maintain the specified pressure over the period of test shall be considered to be the leakage.

Piping will not be accepted until the leakage is less than the maximum allowable leakage determined from the following formula:

$$L = ND \times \text{the square root of } P \text{ in which:}$$

L = the allowable leakage in litres per hour,

N = the number of joints in the test section,

D = the nominal diameter of the pipe in millimetre,

P = the average test pressure during the leakage test in megapascals.

Should any test disclose leakage greater than that specified above, the defect shall be located and repaired, and the section shall be retested to ensure that the leakage is within the allowable limits.

4.4. Cleaning and Flushing

On completion of sewer pipe installation, the pipes shall be cleaned to the satisfaction of the Engineer and the Regional District of Nanaimo.

Sewer lines shall be cleaned and flushed prior to video inspection.

Material displaced from flushing sewer lines shall be collected with a vacuum truck at a downstream manhole. Under no circumstances shall the material be flushed into the downstream system.

4.5. Video Inspection of Sewer Mains

All gravity sewers except services shall be video inspected to check alignment, grade, and condition of the sewer pipe.

1. Video inspections shall be of the following quality:

- (a) Camera lens shall be free of grease or other deleterious matter to ensure optimal clarity.
- (b) Videos shall be free of steaming and fogging encountered during the inspection.
- (c) The camera shall pan to the service connections and pause for at least five seconds.
- (d) Illumination depth of field shall be no less than 3 joints for standard joint and spigot pipe types to allow for pipe deflection assessments (9m). No dark circle shall be visible in the middle of this depth of field viewing area.

2. The inspections submission shall include:

- (a) A pipe condition report including code descriptions used for describing the condition of the pipe.
- (b) Video shall be submitted on a 4.7GB DVD.

The Engineer shall review all videos and certify that the pipe is installed in accordance with these standards and in accordance with the manufactures recommendations.

If directed by the Engineer, the contractor shall arrange for a re-inspection of the pipe at the contractors cost, for the warranty inspection one month prior to the end of the maintenance period.

Video inspection and pipe condition coding shall be undertaken only by personnel with current certification by a Regional District approved agency.

If video inspection does not meet the standards set out here, the contractor shall re-video and re-submit the video at their own cost.

4.6. Inspection

1. The Regional District of Nanaimo shall be given 48 hours notice of all tests.

5. TRANSFERRING THE SEWER SYSTEM TO THE RDN

5.1 *Final Inspection by RDN*

Prior to requesting a Final Inspection, the registered B.C. Professional Civil Engineer shall submit to the Regional District complete Record Documents, a completed letter Certification of Installed Works, all applicable inspection and test results (video inspection DVD's, leakage testing, etc.), and Certificate of Approval for electrical works (pump stations, wells, lighting, controls, etc.) The Final Inspection shall be arranged by the Professional Engineer on completion of the work. This shall be directed by the Professional Engineer in the presence of approved representatives of the Regional District and the installation Contractor. A complete list of deficiencies identified during the final inspection shall be prepared by the Professional Engineer. Once the deficiencies have been satisfactorily rectified, the Professional Engineer shall so notify the Regional District. The date of the Final Inspection will generally be regarded as the commencement of the guarantee period, unless significant deficiencies critical to the effective operation of the system are found at the inspection, at the discretion of the Regional District.

5.2 *Preparation/Execution of Transfer Agreement by Developer*

The Developer shall prepare and execute the Transfer Agreement for the works to the Regional District.

5.3 *Preparation/Execution of Maintenance Agreement*

The Developer shall guarantee the workmanship and the performance of the work as per the Maintenance Agreement, from the date of acceptance (generally the RDN final inspection date) for a period of two years. This shall be additionally secured by way of cash or an irrevocable letter of credit in the amount of 5% of the cost of construction as certified by a B.C. Professional Civil Engineer, or \$10,000.00 (whichever is greater).

The RDN may reduce the length of the guarantee period and/or the amount of the security. The RDN may also require additional payment, or payout a credit as appropriate, related to an adjustment of the initial engineering fee to final construction cost values, in accordance with RDN Bylaw No. 1259.03 or most recent amendment. Any change to the guarantee period, security amount or the engineering fee is required to be in writing.

5.4 *Preparation/Execution of Latecomer Agreement*

Where a latecomer agreement may be applicable to a portion of the costs of the works, as agreed by the Regional District and any other applicable jurisdictions, the Developer shall pay all costs of both the Regional District and the Developer associated with the preparation, execution, and registration of the necessary Latecomer Agreement. The Regional District will assume any internal staff costs involved in planning, reviewing, approving, and administering the Latecomer Agreement preparation, and any administrative and financial costs involved during the effective time-period of the agreement. Based on current legislation, a Latecomer Agreement expires 10-years after its initial registration.

5.5 Letter of Acceptance of the Works by RDN

Following completion of all the foregoing requirements, the Regional District will issue the formal Letter of Acceptance of the Works.

The Regional District will also issue a written statement that the new works can be connected to the District's existing system. Such connection shall be undertaken by the applicant under the direct supervision of the District or by the District at a cost to the applicant.

**REGIONAL DISTRICT OF NANAIMO
BYLAW NO. 500**

**LAKES DISTRICT AND SCHOONER COVE
COMMUNITY SEWER SYSTEM STANDARDS**

APPENDIX 1

STANDARD DRAWINGS

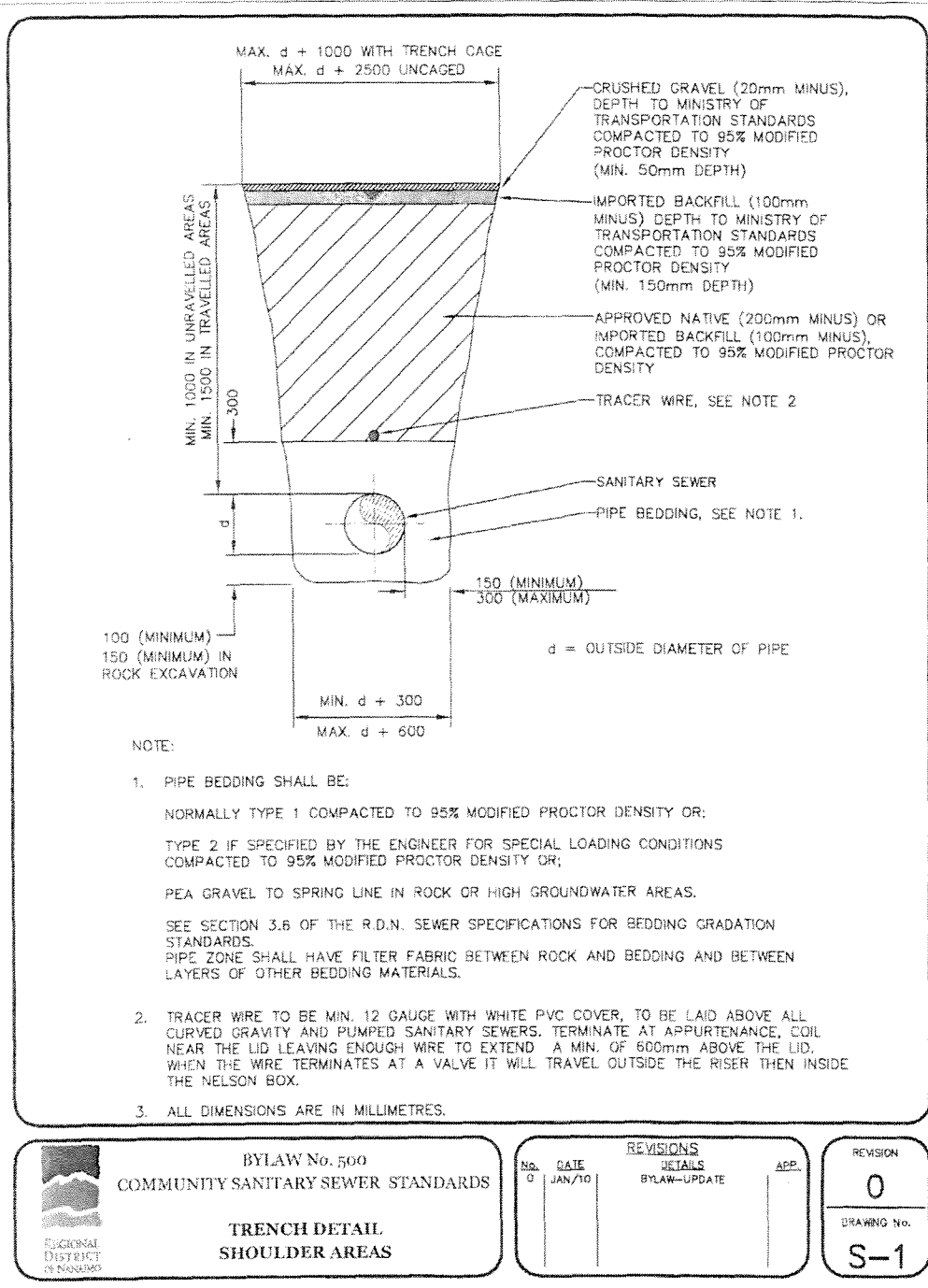



BYLAW No. 500
COMMUNITY SANITARY SEWER STANDARDS

**TRENCH DETAIL
SHOULDER AREAS**

REVISIONS			APP.
No.	DATE	DETAILS	
0	JAN/10	BYLAW-UPDATE	

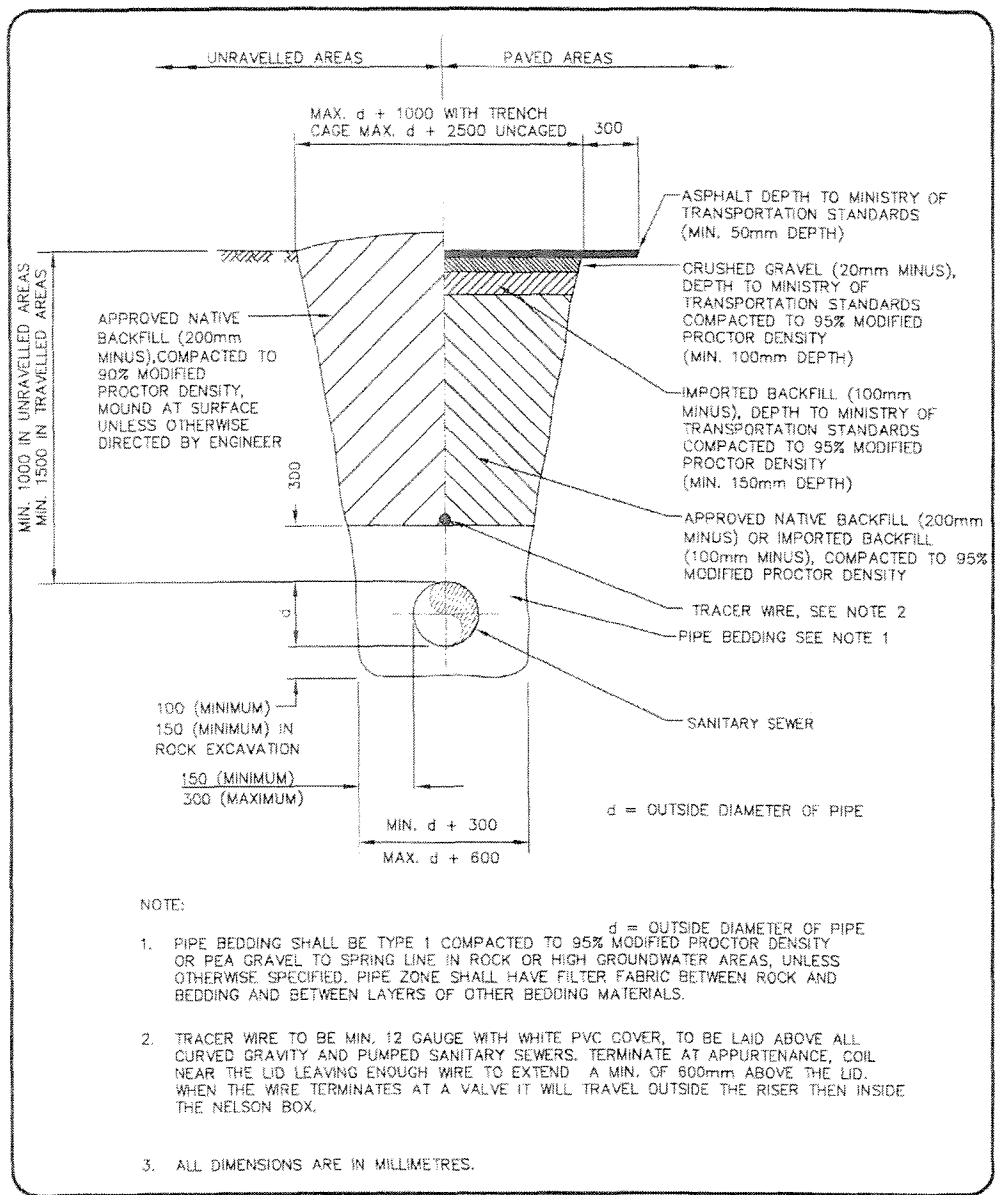
REVISION
0
DRAWING No.
S-1



 BYLAW No. 500
COMMUNITY SANITARY SEWER STANDARDS

**TRENCH DETAIL
PAVED & UNRAVELLED AREAS**

REVISIONS			
No.	DATE	DETAILS	APP.
0	JAN/10	BYLAW-UPDATE	

REVISION
0

DRAWING No.
S-2

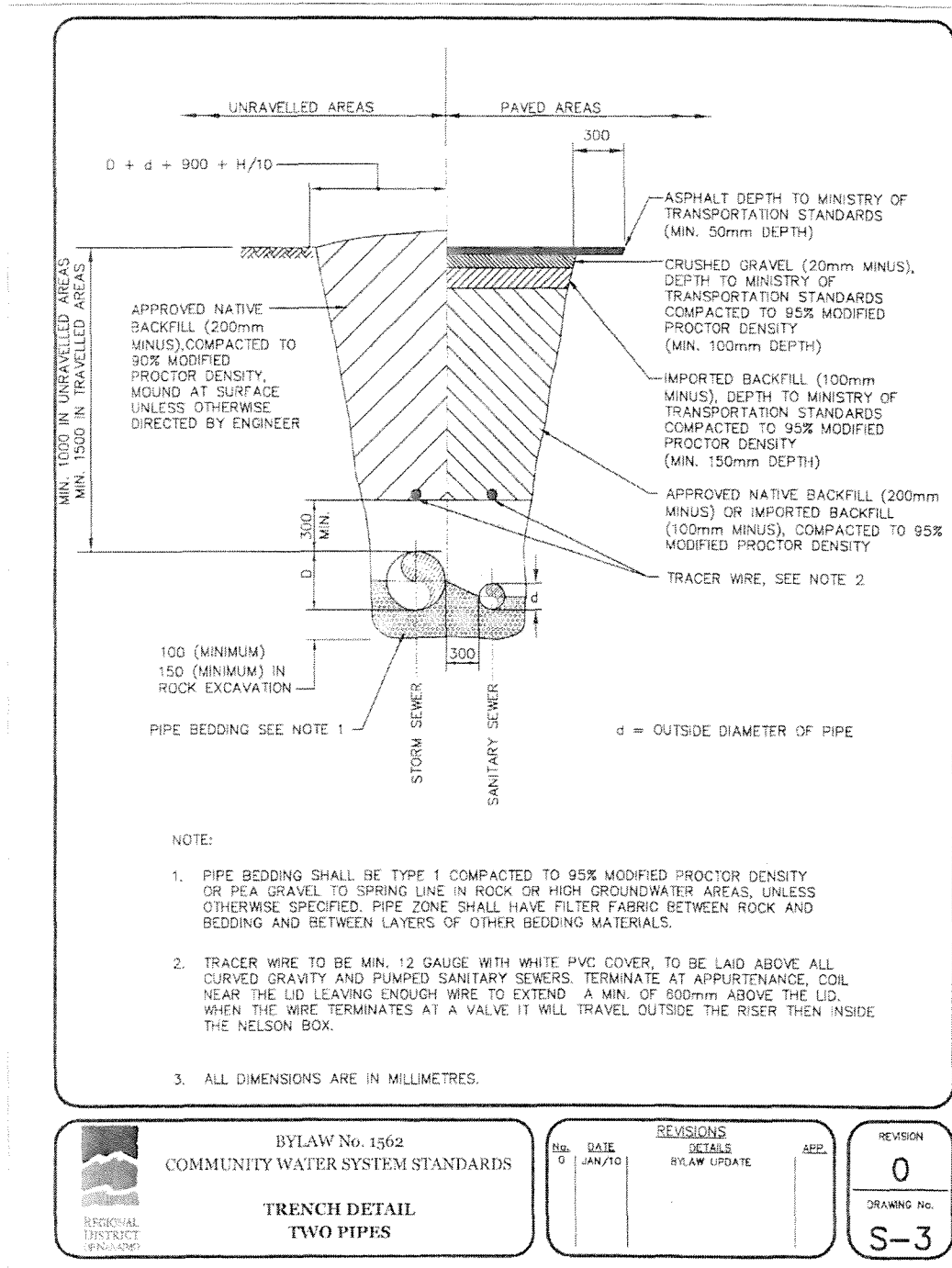

BYLAW No. 1562
COMMUNITY WATER SYSTEM STANDARDS

TRENCH DETAIL
TWO PIPES

REVISIONS		
No.	DATE	DETAILS
0	JAN/10	BYLAW UPDATE
		APP.

REVISION
0
DRAWING No.
S-3

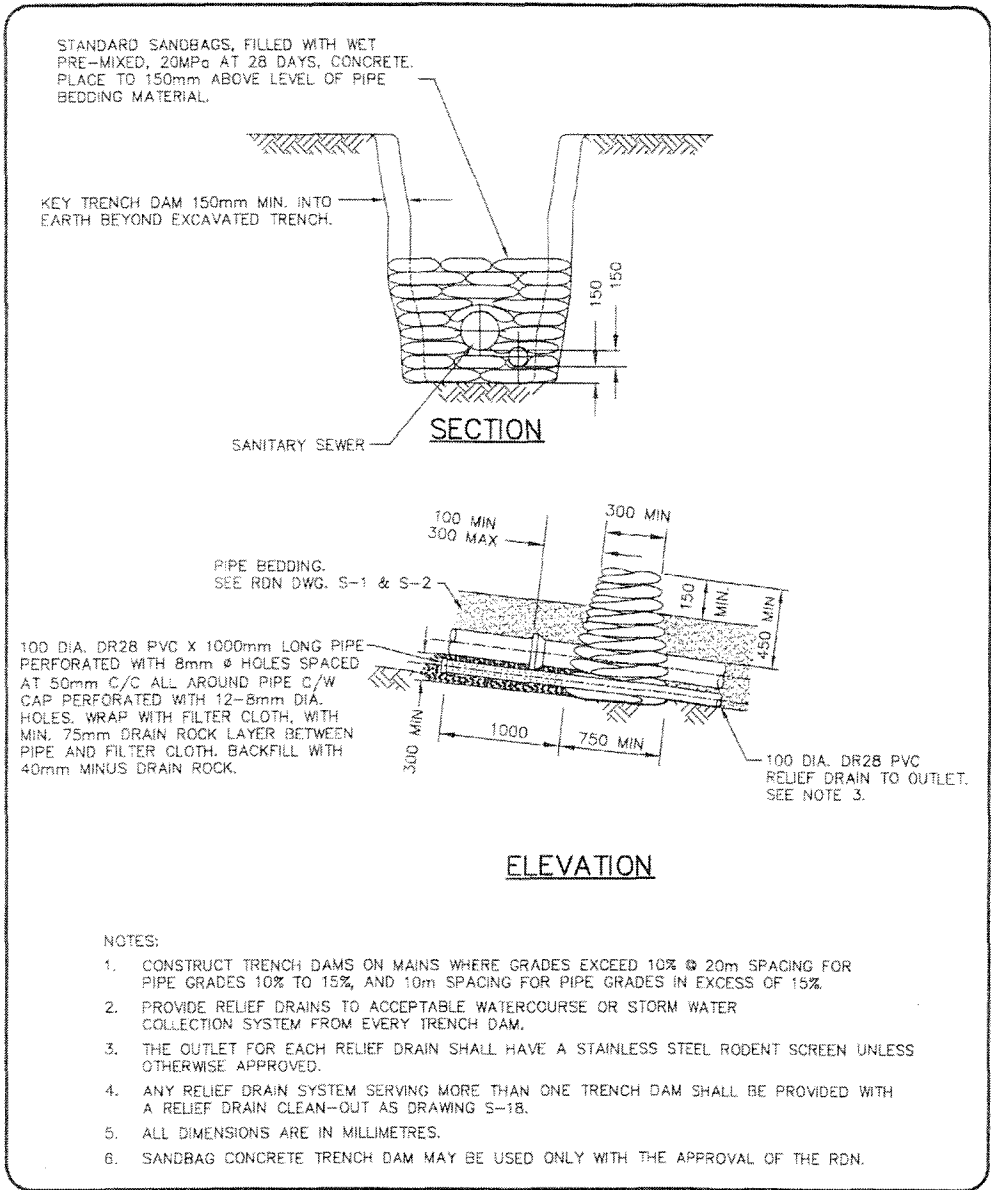

BYLAW No. 500
COMMUNITY SANITARY SEWER STANDARDS

**TRENCH DAM
SANDBAG CONCRETE**

REVISIONS			
No.	DATE	DETAILS	APP.
0	JAN/10	BYLAW-UPDATE	

REVISION
0

DRAWING No.
S-4

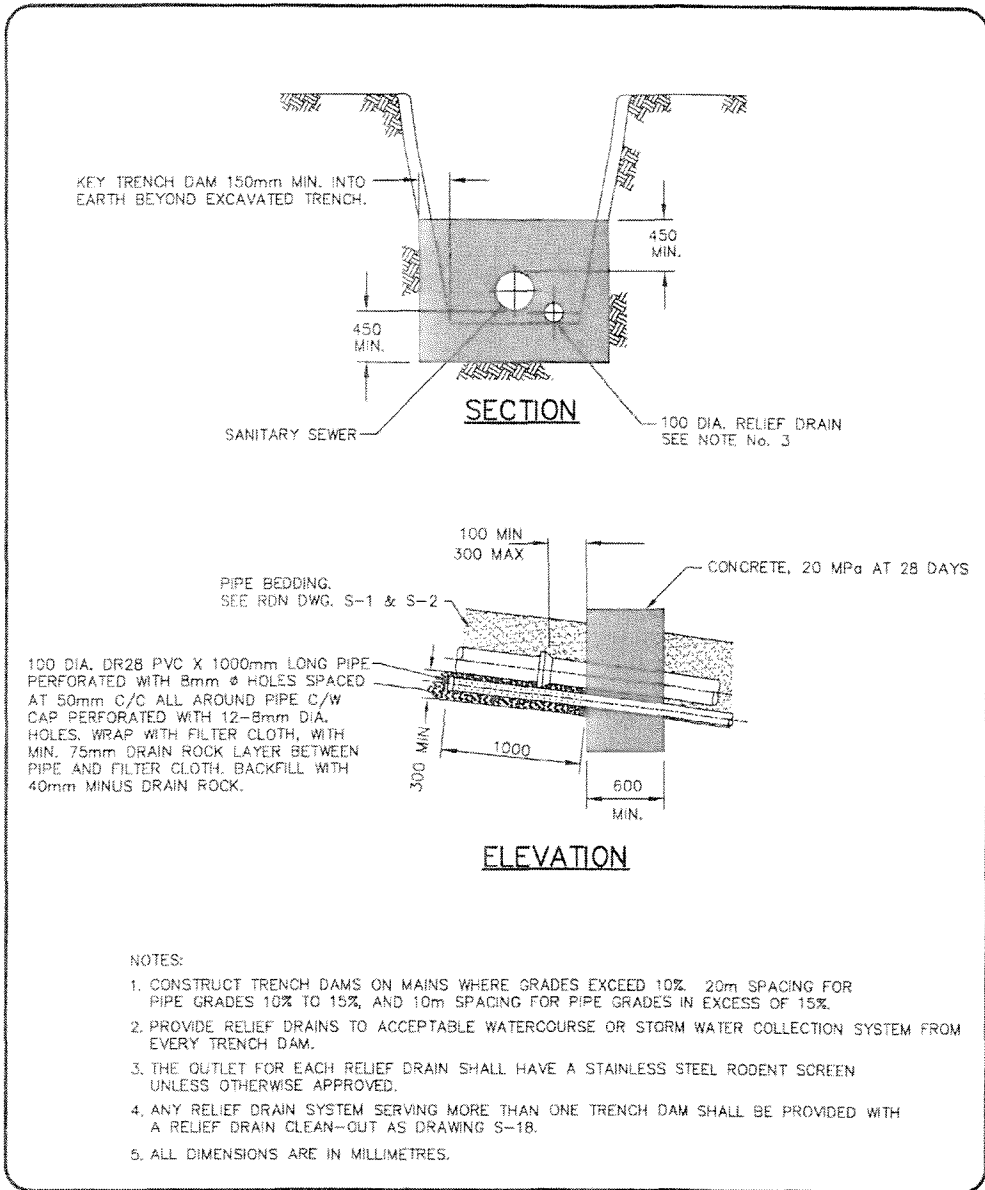

 REGIONAL DISTRICT KIMIKOBE	BYLAW No. 500 COMMUNITY SANITARY SEWER STANDARDS	REVISIONS No. DATE DETAILS APP. 0 JAN/10 BYLAW-UPDATE	REVISION 0 DRAWING No. S-5
	TRENCH DAM FORMED CONCRETE		

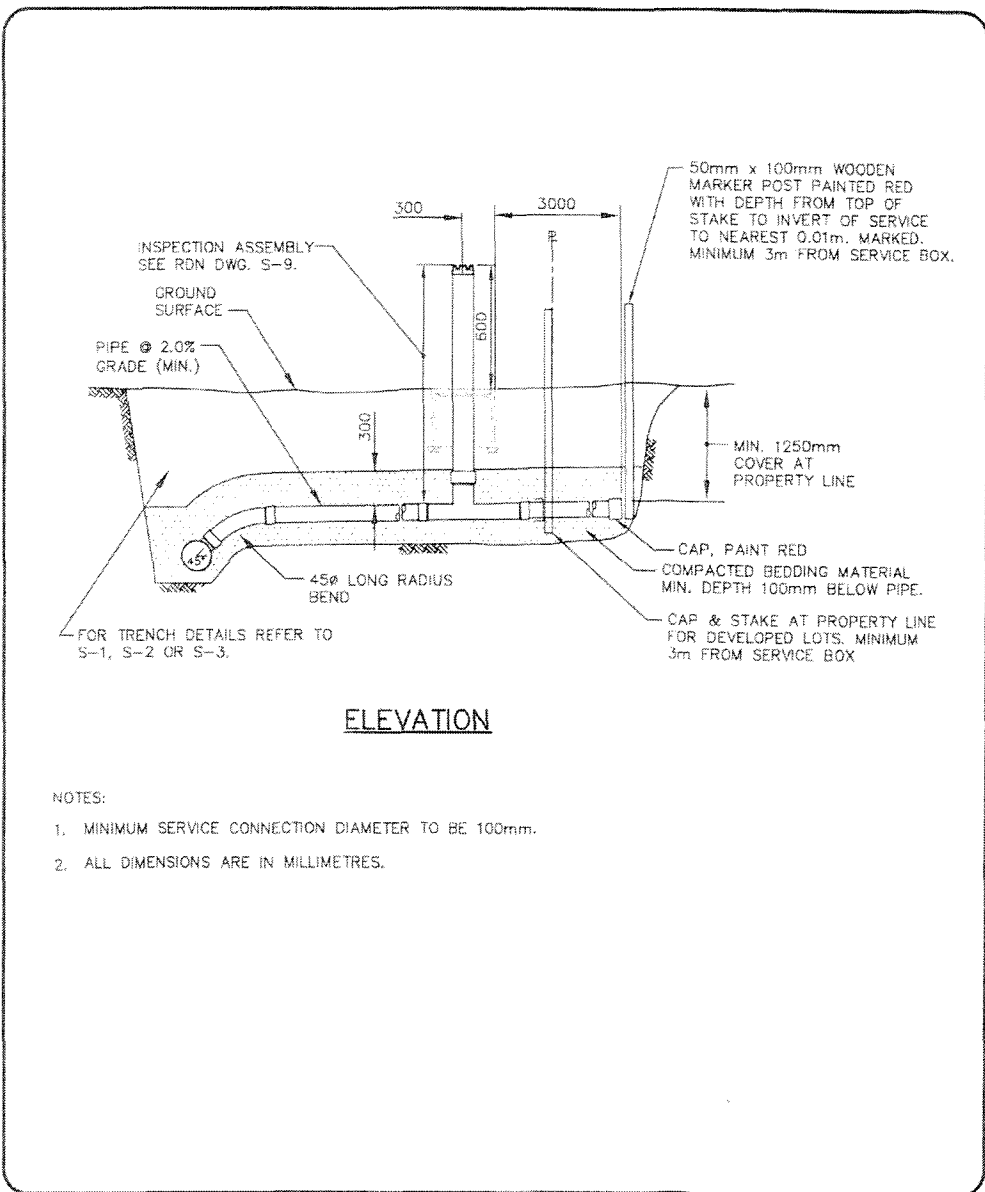

ELEVATION

NOTES:

1. MINIMUM SERVICE CONNECTION DIAMETER TO BE 100mm.
2. ALL DIMENSIONS ARE IN MILLIMETRES.

	BYLAW No. 500 COMMUNITY SANITARY SEWER STANDARDS	REVISIONS No. DATE DETAILS APP.	REVISION 0
	SERVICE CONNECTION	0 JAN/10 BYLAW-UPDATE	S-6

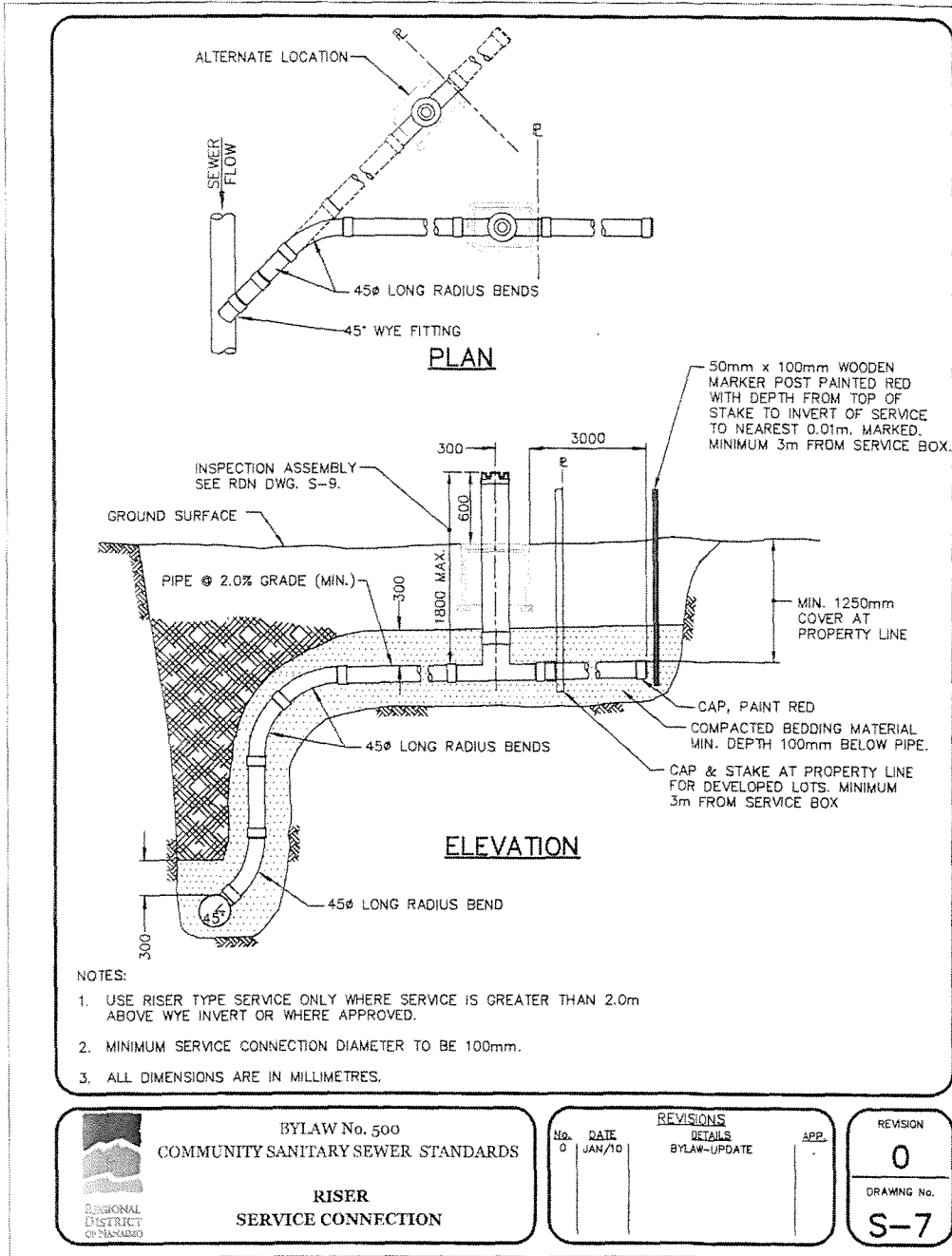



BYLAW No. 500
COMMUNITY SANITARY SEWER STANDARDS

**RISER
SERVICE CONNECTION**

No.	DATE	REVISIONS		APP.
		DETAILS		
0	JAN/10	BYLAW-UPDATE		

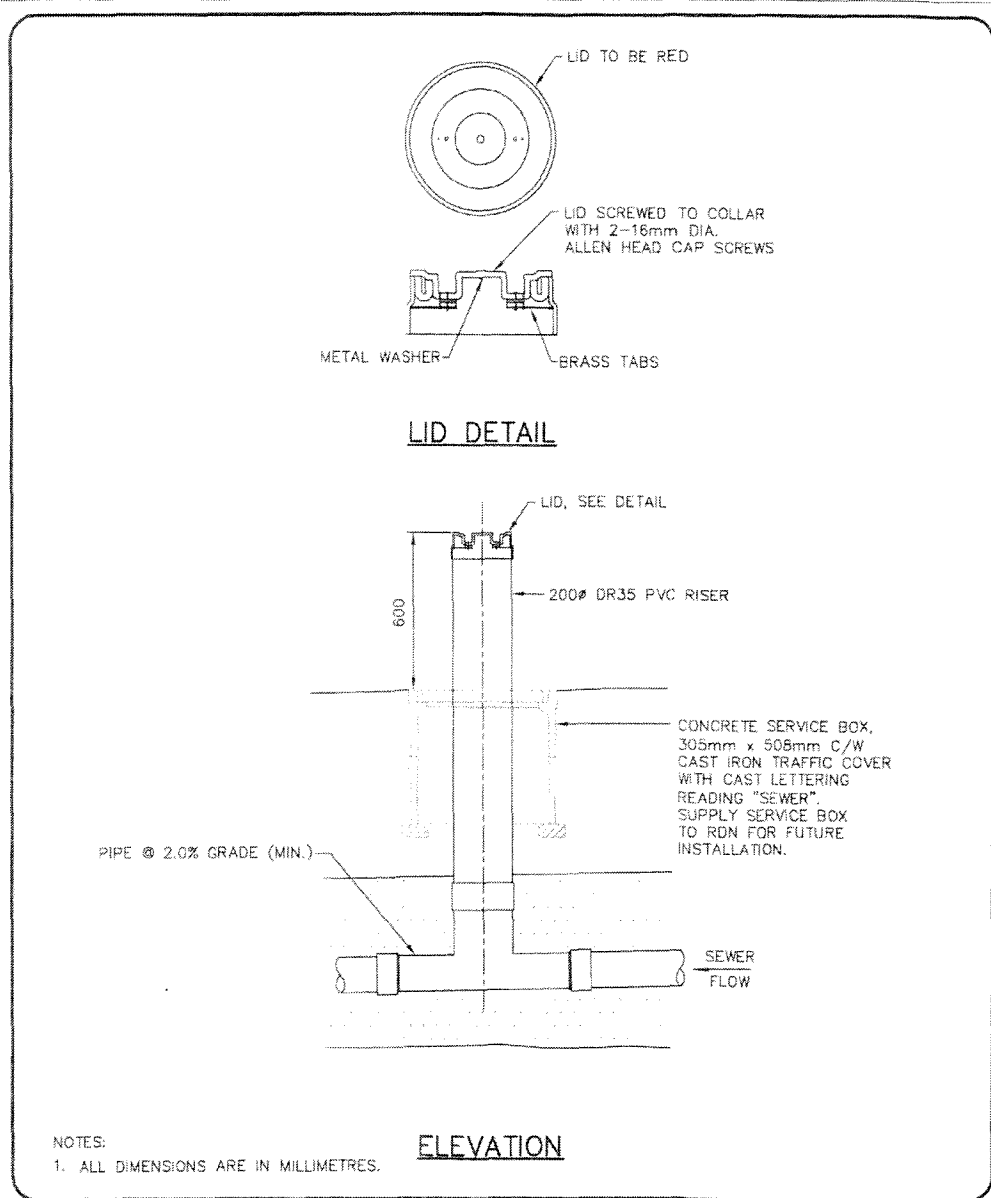
REVISION
0
DRAWING No.
S-7



 BYLAW No. 500
 COMMUNITY SANITARY SEWER STANDARDS
**SERVICE CONNECTION
 INSPECTION ASSEMBLY**

REVISIONS		
No.	DATE	DETAILS
0	JAN/10	BYLAW-UPDATE
		APP.

REVISION
0
S-8

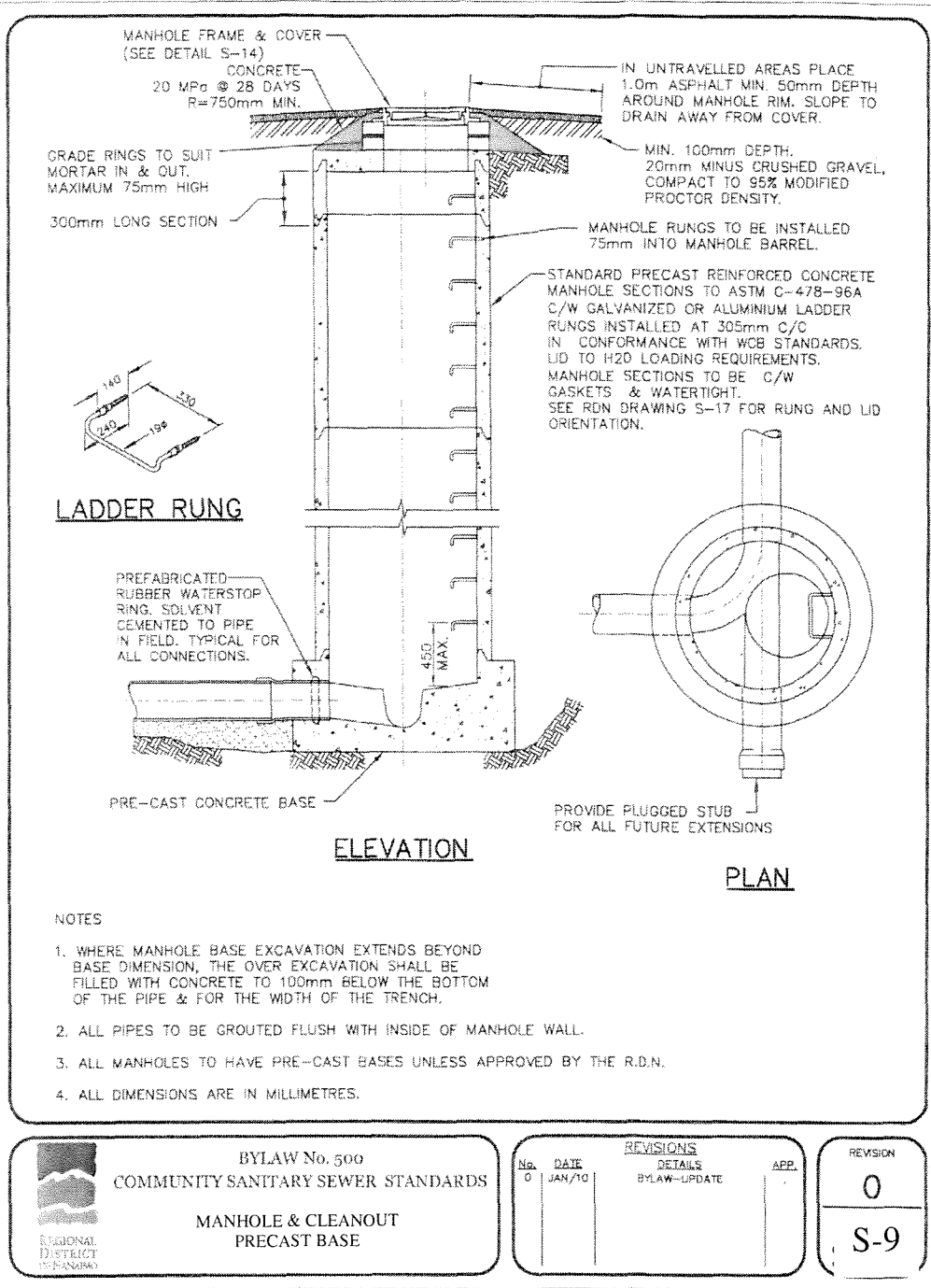

BYLAW No. 500
COMMUNITY SANITARY SEWER STANDARDS
MANHOLE & CLEANOUT
PRECAST BASE

REVISIONS			APP.	REVISION
No.	DATE	DETAILS		
0	JAN/10	BYLAW-UPDATE		0
				S-9

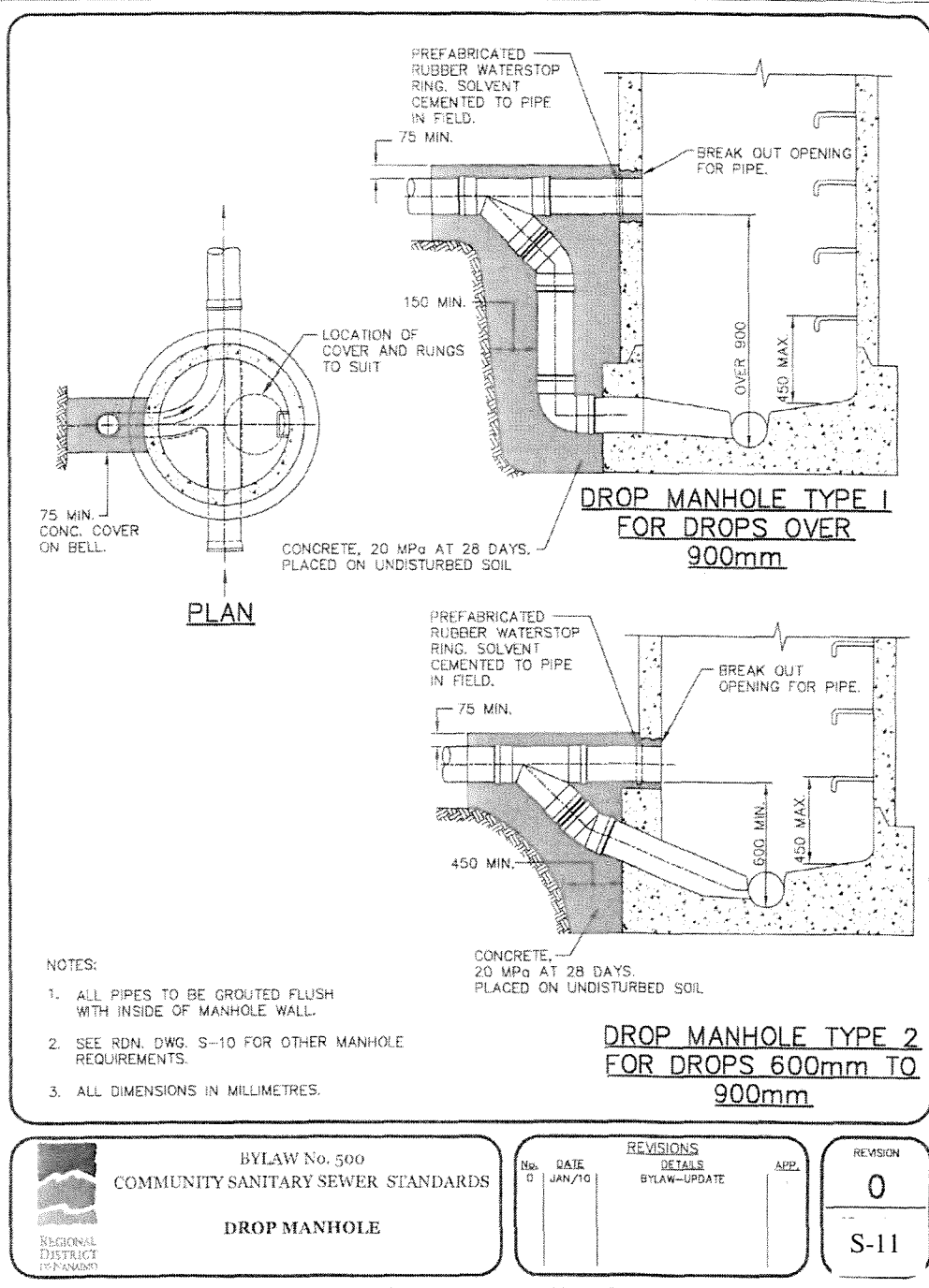

BYLAW No. 500
COMMUNITY SANITARY SEWER STANDARDS
DROP MANHOLE

No.	DATE	REVISIONS		APP.
		DETAILS		
0	JAN/10	BYLAW-UPDATE		

REVISION
0
S-11

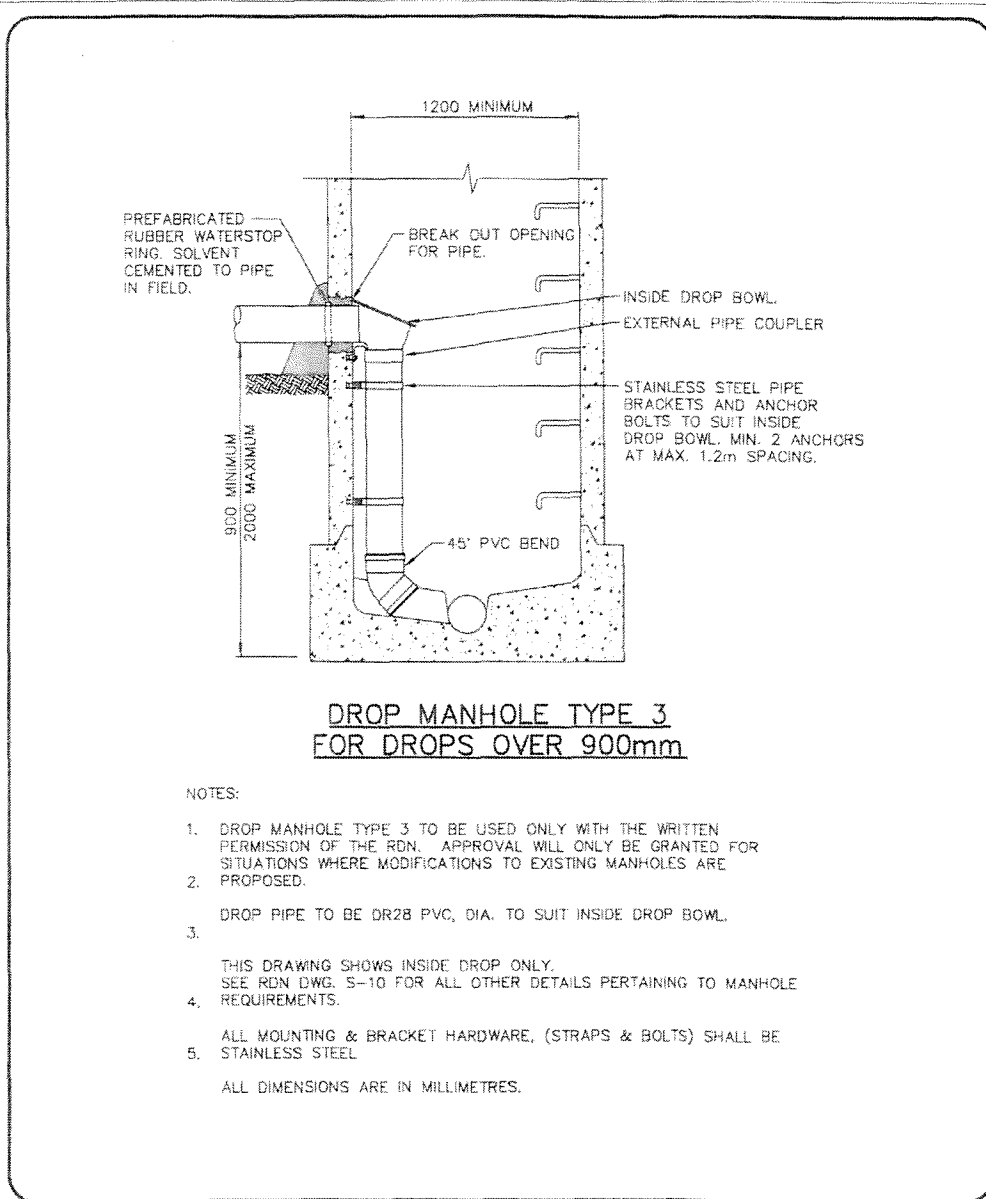

BYLAW No. 500
COMMUNITY SANITARY SEWER STANDARDS
INSIDE DROP MANHOLE DETAILS

REVISIONS			APP.	REVISION
No.	DATE	DETAILS		
0	JAN/10	BYLAW-UPDATE		

REVISION
0
S-12

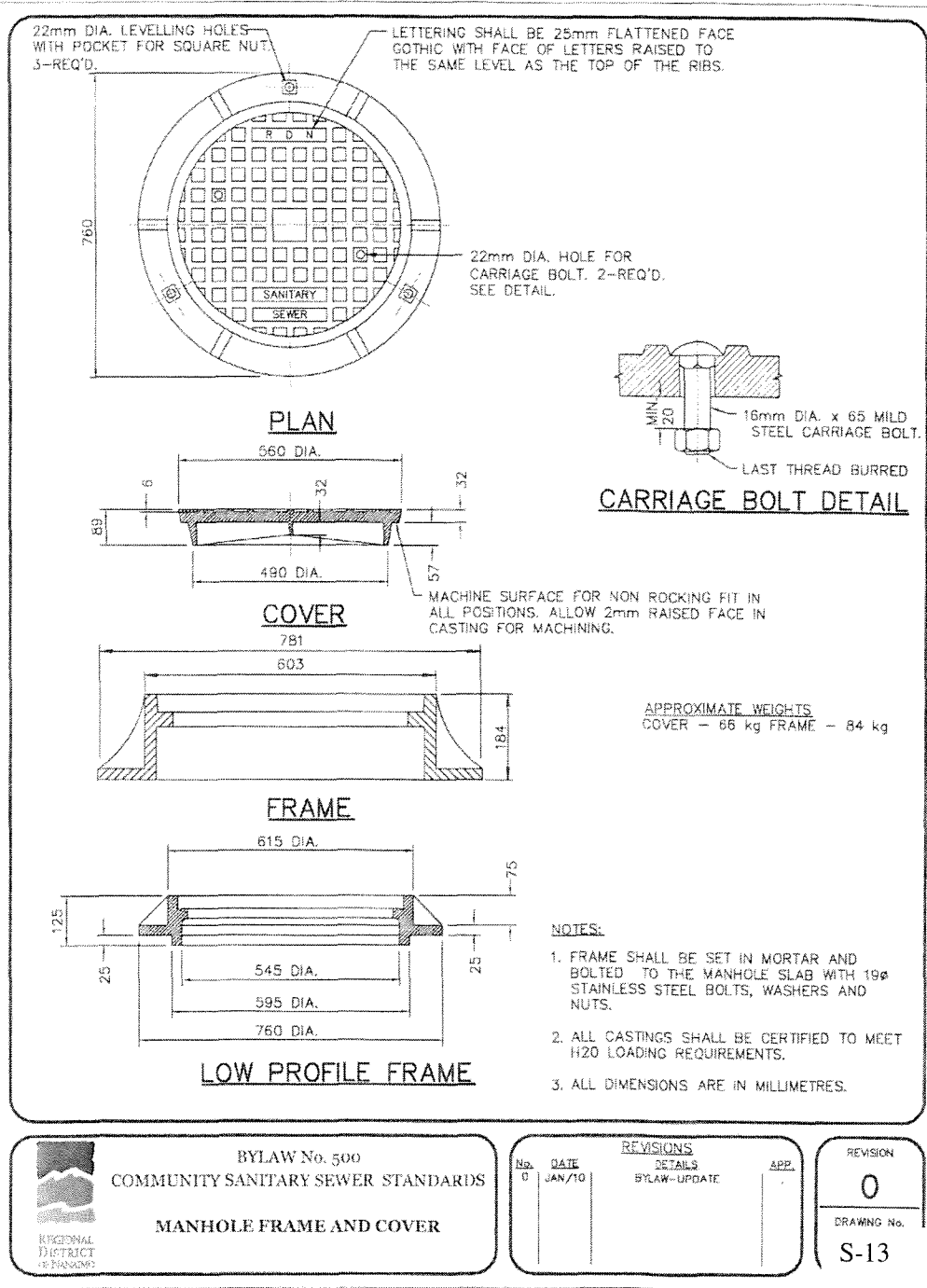



BYLAW No. 500
COMMUNITY SANITARY SEWER STANDARDS
MANHOLE FRAME AND COVER

REVISIONS		
No.	DATE	DETAILS
0	JAN/10	BYLAW-UPDATE

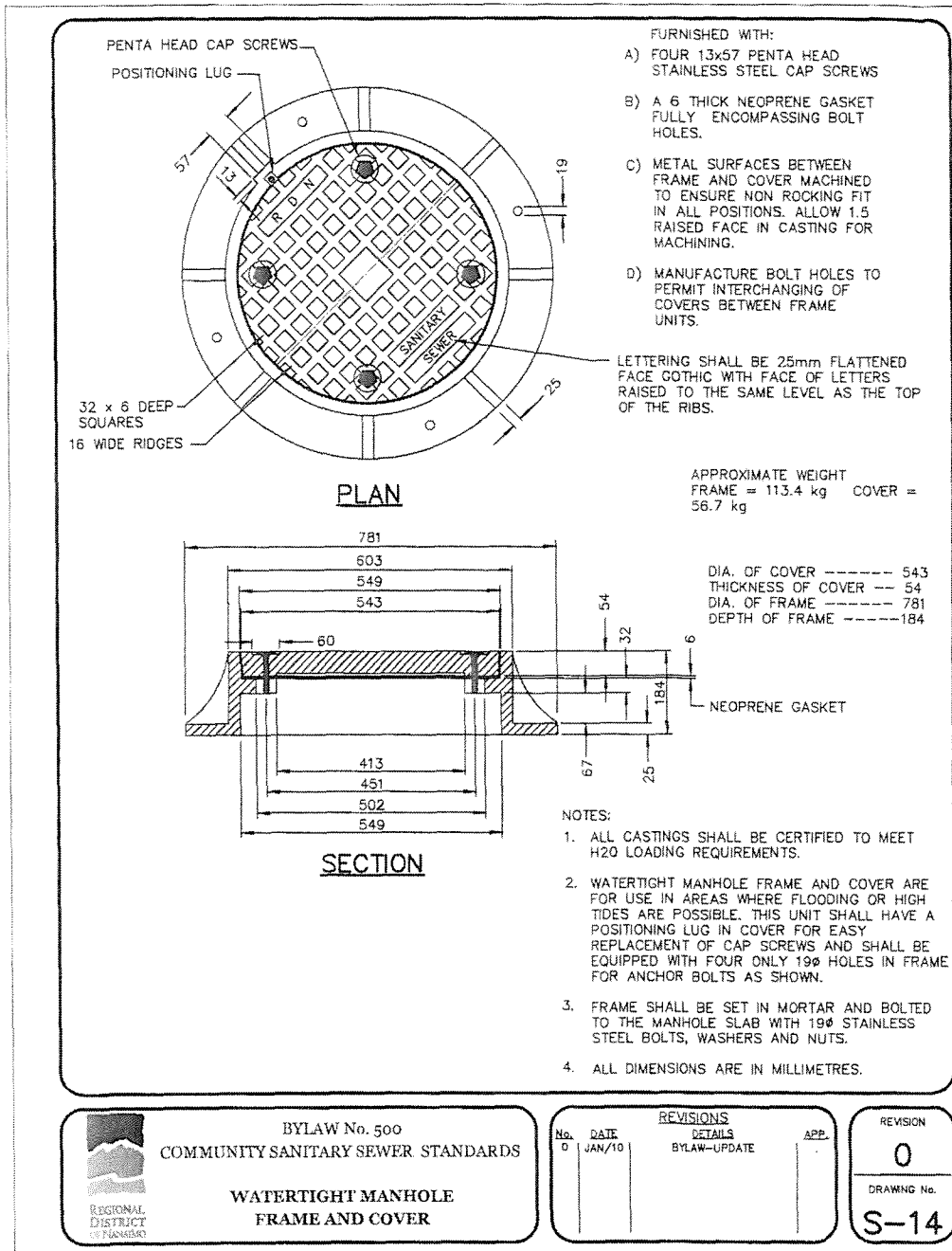
REVISION
0
DRAWING No.
S-13

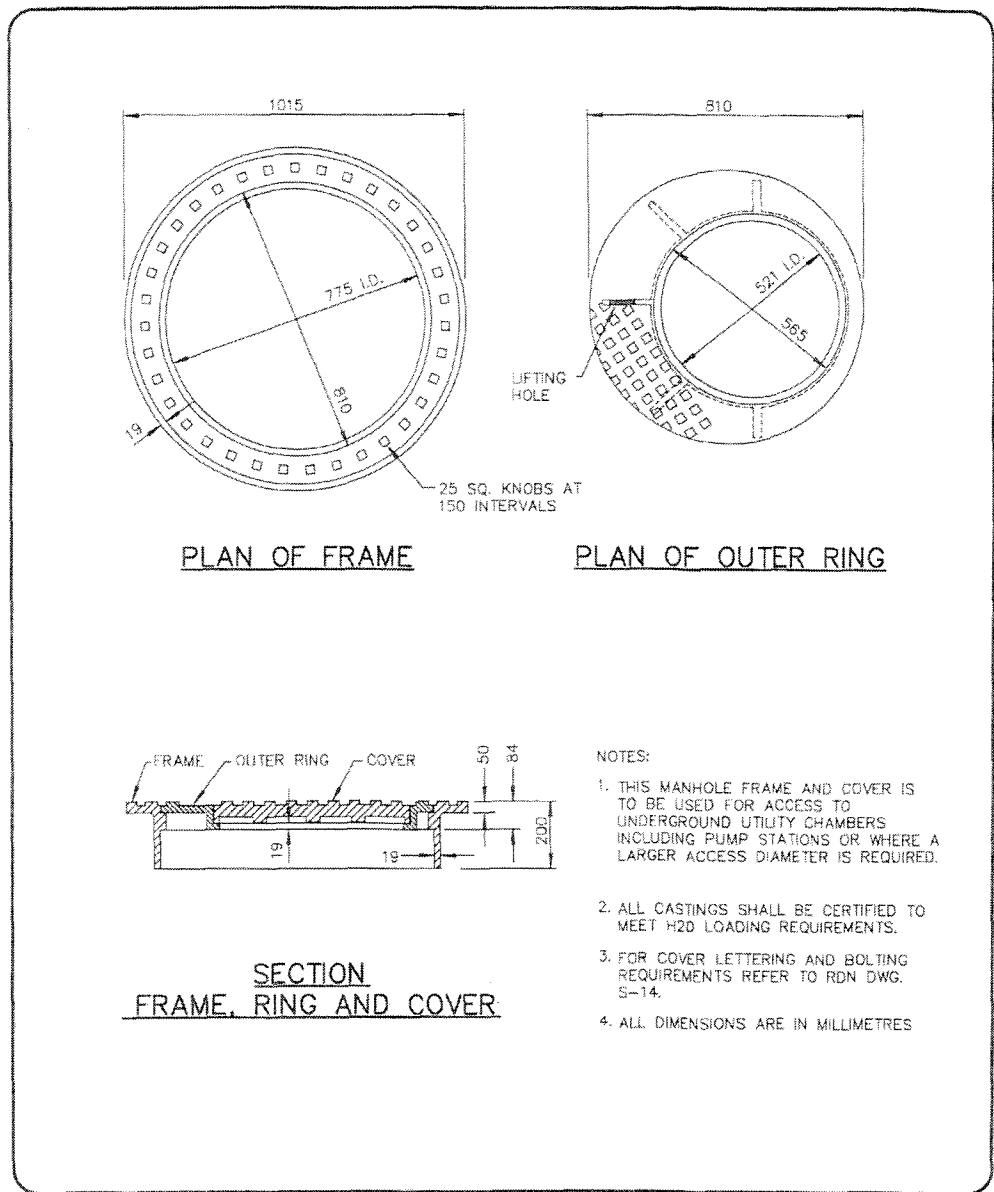



 BYLAW No. 500
 COMMUNITY SANITARY SEWER STANDARDS
 UTILITY CHAMBER
 MANHOLE FRAME, RING AND COVER

REVISIONS			APP.
No.	DATE	DETAILS	
0	JAN/10	BYLAW-UPDATE	

REVISION
0
 DRAWING No.
S-15

1. RIGHT ANGLE BEND 2. TEE CONNECTION 3. THREE WAY JUNCTION

4. FOUR WAY JUNCTION 5. STRAIGHT THROUGH 6. DEAD END

7. WYE CONNECTION 8. 45° BEND

NOTES

1. ALL CHANNELS SHALL BE FINISHED WITH A STEEL TROWEL. BENCHING (SHADED AREAS) SHALL BE BROOM FINISHED.
2. MANHOLE COVER OPENINGS AND RUNG LOCATIONS SHALL BE AS SHOWN UNLESS OTHERWISE NOTED ON THE CONSTRUCTION DRAWINGS.

<p>REGIONAL DISTRICT OF NANAIMO</p>	<p>BYLAW No. 500 COMMUNITY SANITARY SEWER STANDARDS</p> <p>CAST IN PLACE MANHOLE BENCHING</p>		<p>REVISIONS</p> <table border="1" style="width: 100%; border-collapse: collapse;"> <thead> <tr> <th style="width: 10%;">No.</th> <th style="width: 15%;">DATE</th> <th style="width: 50%;">DETAILS</th> <th style="width: 10%;">APP.</th> </tr> </thead> <tbody> <tr> <td>0</td> <td>JAN/10</td> <td>BYLAW-UPDATE</td> <td></td> </tr> </tbody> </table>			No.	DATE	DETAILS	APP.	0	JAN/10	BYLAW-UPDATE		<p>REVISION</p> <p style="font-size: 24px;">0</p>
	No.	DATE	DETAILS	APP.										
0	JAN/10	BYLAW-UPDATE												
			<p style="font-size: 24px;">S-16</p>											

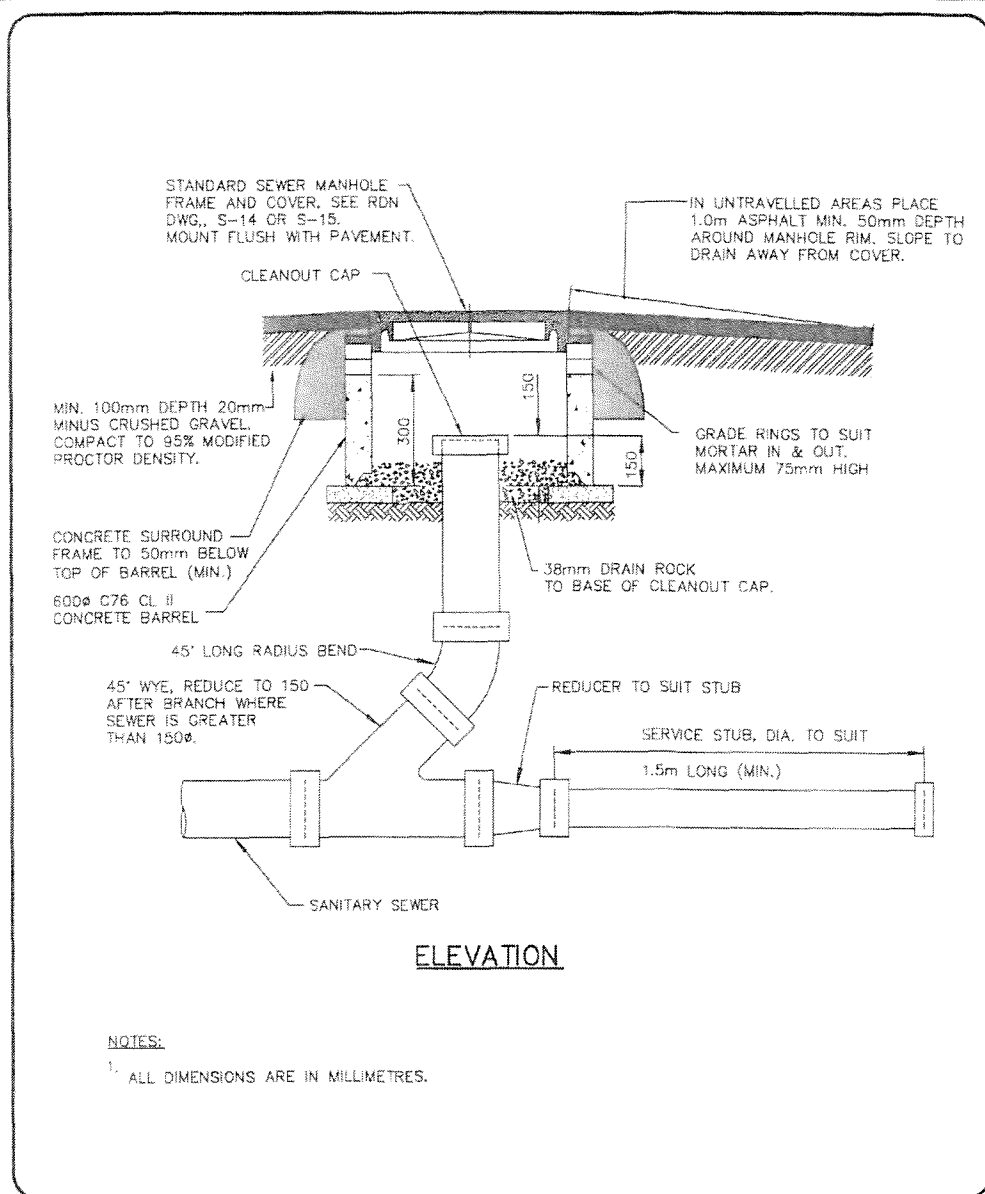



 BYLAW No. 500
 COMMUNITY SANITARY SEWER STANDARDS
**CLEANOUTS
 WITH SERVICE EXTENSION**

No.	DATE	REVISIONS		APP.
		DETAILS		
0	JAN/10	BYLAW-UPDATE		

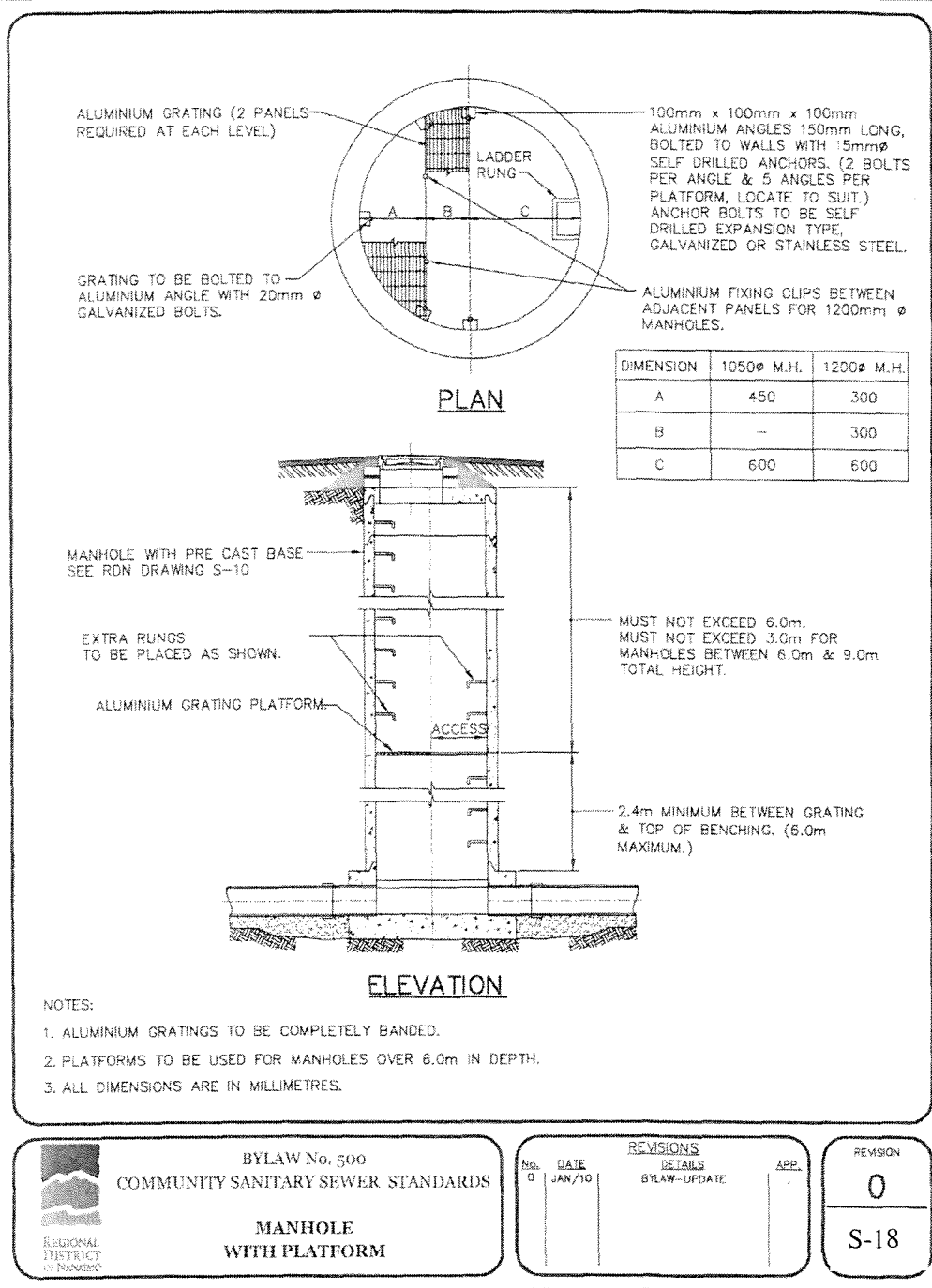
REVISION
0
S-17

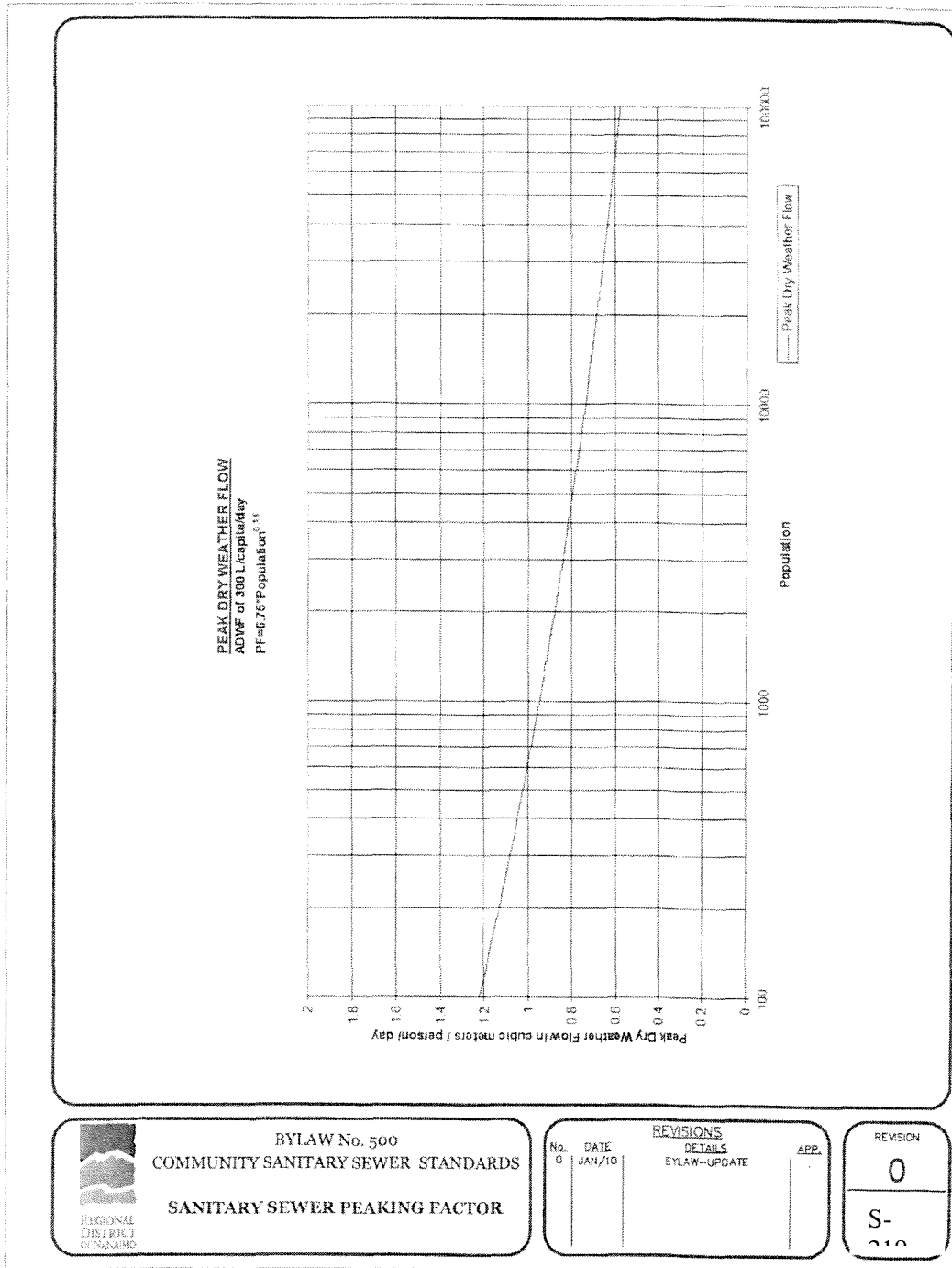



**REGIONAL DISTRICT OF NANAIMO
BYLAW NO. 500**

**LAKES DISTRICT AND SCHOONER COVE
COMMUNITY SEWER SYSTEM STANDARDS**

APPENDIX 2

LETTER OF ASSURANCE



LETTER OF ASSURANCE

NOTE:

To be submitted at time of Feasibility Review

To: Manager of Engineering Services
 Regional District of Nanaimo
 6300 Hammond Bay Road
 Nanaimo BC V9T 6N2

RE: _____

 (Project)

Date: _____, 20__.

This will confirm that (Developer _____) has retained (Consultant _____) to provide, design, contract administration, inspection and as-constructed drawings for this project all in accordance with the current bylaws and standards of the Regional District and in accordance with good engineering practice.

(Developer)

This confirms we have accepted this assignment on the above terms.

(Consultant)

**REGIONAL DISTRICT OF NANAIMO
BYLAW NO. 500**

**LAKES DISTRICT AND SCHOONER COVE
COMMUNITY SEWER SYSTEM STANDARDS**

APPENDIX 3

CERTIFICATE OF DESIGN



CERTIFICATE OF DESIGN

I, _____, a Professional Engineer registered in the Province of British Columbia, hereby certify that the works as herein set out on the attached drawings entitled _____

_____ have been designed in accordance with the Regional District of Nanaimo Bylaw 500 and/or in accordance with good engineering practice where such design is not covered by the Regional District Bylaw 500.

I have been retained to provide design, supervision, full-time inspection, as-built drawings, and final certification for this project by:

(Name of Client)

I am satisfied that in the contractual mandate which exists between myself and my client, the terms of reference will permit me to render a level of supervision of the construction work which will allow me to put my name and seal to the "Certification of Installed Works" required by the Regional District of Nanaimo, a sample of which is attached to this document and initialed by me.

In the event that my client releases me from this project, or in the event that I find the terms of reference do not permit me to render a level of supervision of the construction work which will allow me to put my name and seal to the form of certification required by the Regional District of Nanaimo, I will notify the Regional District within twenty-four (24) hours verbally and follow it up with written confirmation and clarification.

Signed this _____ day of _____, 20____.

_____, P.Eng.

(signature)

(name printed)

I understand that the "Certification of Installed Works" is to be completed in this format and submitted with the "as-constructed" drawings.

(Engineer)

**REGIONAL DISTRICT OF NANAIMO
BYLAW NO. 500**

**LAKES DISTRICT AND SCHOONER COVE
COMMUNITY SEWER SYSTEM STANDARDS**

APPENDIX 4

CERTIFICATION OF INSTALLED WORKS

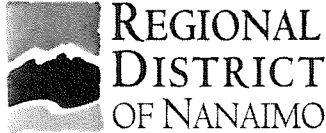

CERTIFICATION OF INSTALLED WORKS

NOTE: To be completed in this format and submitted with the 'As-Built' drawings

Location of the Construction Site and Works: (Legal Description / Location)

_____ all within the Regional District of Nanaimo, British Columbia.

I, _____, a Registered Professional Engineer (Reg. No. _____) in the Province of British Columbia, hereby certify:

4. THAT the following construction tests were carried out to confirm that construction met the specifications required:

- a) _____
- b) _____
- c) _____
- d) _____
- e) _____
- f) _____

5. THAT I was able to monitor the construction and provide a level of supervision of the construction work sufficient to be able to confirm that the specifications in force and effect by the Regional District of Nanaimo and in the applicable design drawings for the said Works were generally met during the Construction Period; and

6. THAT the accompanying plans labeled:

- (i) _____
- (ii) _____
- (iii) _____

accurately record the materials, grades, inverts, offsets and dimensions of the constructed work.

DATED this _____ day of _____, 20 _____.

Engineer (signature & seal)

Engineering Firm

**REGIONAL DISTRICT OF NANAIMO
BYLAW NO. 500**

**LAKES DISTRICT AND SCHOONER COVE
COMMUNITY SEWER SYSTEM STANDARDS**

APPENDIX 5

STANDBY IRREVOCABLE LETTER OF CREDIT

[BANK LETTERHEAD]

Letter of Credit No. _____ Amount: _____
Applicant _____ Initial Expiry Date: _____
_____ Beneficiary: _____

For the account of _____
(Name of Customer)

up to an aggregate amount of _____ available on demand.

Pursuant to the request of our customer, we hereby establish and give you a Standby Irrevocable Letter of Credit in your favour in the above amount which may be drawn on by you at any time and from time to time, upon written demand for payment made upon us by you, which demand we shall honour without enquiring whether you have the right as between yourself and the said customer to make such demand, and without recognizing any claim of our said customer, or objection by it to payment by us.

This Letter of Credit relates to those Regional District of Nanaimo services and financial obligations set out in an Agreement between the customer and the Regional District of Nanaimo and briefly described as:

The amount of this Letter of Credit may be reduced from time to time as advised by notice in writing to us by the Regional District of Nanaimo.

Partial or full drawings may be made.

This Letter of Credit shall expire at 3:00 p.m. on _____. This Letter of Credit will continue in force for a period of 1 year, but shall be subject to the condition hereinafter set forth.

It is a condition of the Letter of credit that it shall be deemed to be automatically extended without amendment from year to year from the present or any future expiration date hereof, unless at least 30 days prior to the present or any future expiration date, we notify you in writing by registered mail, that we elect not to consider this Letter of Credit to be renewable for any additional period. This Letter of Credit is subject to the Uniform Custom and Practice for Documentary Credits (1993 Revision) International Chamber of Commerce Publication No. 500.

DATED at _____, British Columbia, this ____ day of _____, 20__.

(Name of Bank)

(Address of Bank)

PER: _____
(Authorized Signature)

Chairperson

Corporate Officer

Schedule '3'
Lakes District and Schooner Cove Community Water and Sewer Standards Area

