PROVINCE OF BRITISH COLUMBIA
MINISTRY OF ENVIRONMENT, LANDS AND PARKS
VANCOUVER ISLAND REGION

QUALICUM RIVER
WATER ALLOCATION PLAN

August 1996

written by:

Zehra Pirani
&
George Bryden

Regional Water Management
Vancouver Island Region
Nanaimo, B.C.

Approved:

Regional Water Manager
Vancouver Island Region

Date:

29 August 1996

Table of Contents

TABLE OF CONTENTS.....	i
LIST OF TABLES.....	ii
LIST OF FIGURES.....	ii
APPENDICES.....	iii
1.0 INTRODUCTION.....	1
2.0 GENERAL WATERSHED INFORMATION.....	2
2.1 GEOGRAPHY AND MORPHOLOGY.....	2
2.2 CLIMATE.....	2
2.3 GEOLOGY AND GROUNDWATER.....	2
2.4 HISTORY AND DEVELOPMENT.....	3
2.5 SIGNIFICANT DRAINAGE AREAS.....	4
3.0 HYDROLOGY.....	7
3.1 PRECIPITATION.....	7
3.2 HYDROMETRIC INFORMATION.....	8
3.3 STREAM FLOW ESTIMATES.....	11
3.3.1 Little Qualicum River Drainage.....	11
3.3.1.1 Whisky Creek Drainage.....	15
3.3.2 Annie Creek Drainage.....	17
3.3.3 Westglade Brook Drainage.....	19
3.3.4 Qualicum River Drainage.....	21
3.3.5 Low Flows.....	23
3.4 LAKE INFORMATION.....	24
4.0 INSTREAM FLOW REQUIREMENTS.....	25
4.1 LITTLE QUALICUM RIVER INSTREAM REQUIREMENTS.....	28
4.1.1 Whisky Creek Instream Requirements.....	29
4.2 ANNIE CREEK INSTREAM REQUIREMENTS.....	30
4.3 WESTGLADE BROOK INSTREAM REQUIREMENTS.....	31
4.4 QUALICUM RIVER INSTREAM REQUIREMENTS.....	32
5.0 WATER DEMAND.....	34
5.1 LICENCED DEMAND.....	34
5.2 PROJECTED DEMAND.....	36

6.0 CONCLUSIONS AND RECOMMENDATIONS	37
6.1 DOMESTIC	39
6.2 WATERWORKS	40
6.3 IRRIGATION	41
6.4 INDUSTRIAL AND COMMERCIAL	43
6.5 STORAGE.....	44
6.6 LAND IMPROVEMENT	46
6.7 CONSERVATION	46
6.8 ALLOCATION PLAN REVISION	47
REFERENCES	48

List of Tables

TABLE 1: QUALICUM RIVER DRAINAGE AREAS	4
TABLE 2: WATER SURVEY OF CANADA STATIONS USED FOR REGIONALIZATION	9
TABLE 3: DISCHARGE AND DISCHARGE RUNOFF PER SQUARE KILOMETRE 1960-77	11
TABLE 4: LITTLE QUALICUM RIVER AT OUTLET OF CAMERON LAKE (08HB004)	12
TABLE 5: LITTLE QUALICUM RIVER NEAR QUALICUM BEACH (08HB029)	13
TABLE 6: WHISKY CREEK MEAN MONTHLY AND MEAN ANNUAL DISCHARGE	15
TABLE 7: ANNIE CREEK MEAN MONTHLY AND MEAN ANNUAL DISCHARGE	17
TABLE 8: WESTGLADE BROOK MEAN MONTHLY AND MEAN ANNUAL DISCHARGE	19
TABLE 9: QUALICUM RIVER NEAR BOWSER (08HB001).....	21
TABLE 10: QUALICUM RIVER AT OUTLET OF HORNE LAKE (08HB018)	22
TABLE 11: DRAINAGE AREA, MAD, MIN MMD AND MEAN 7-DAY AVERAGE LOW FLOW	24
TABLE 12: LAKE INFORMATION	24
TABLE 13: MODIFIED TENNANT (MONTANA) METHOD INSTREAM FLOW REQUIREMENTS	25
TABLE 14: ESTIMATED AVERAGE ANNUAL LICENCED WATER DEMAND.....	35
TABLE 15: LOW FLOW LICENCED (CONSUMPTIVE WATER DEMAND PER DRAINAGE AREA.....	36
TABLE 16: QUALICUM RIVER - WATER AVAILABILITY	39
TABLE 17: RECOMMENDED LIVESTOCK REQUIREMENTS	44

List of Figures

FIGURE 1: QUALICUM RIVER WATER ALLOCATION PLAN	5
FIGURE 2: QUALICUM RIVER WATER ALLOCATION PLAN SIGNIFICANT DRAINAGE AREAS	6
FIGURE 3: AES STATION PRECIPITATION NORMALS.....	8
FIGURE 4: QUALICUM RIVER WATER ALLOCATION PLAN FLOW MEASUREMENT STATIONS	10
FIGURE 5: LITTLE QUALICUM RIVER AT OUTLET OF CAMERON LAKE (08HB004).....	13
FIGURE 6: LITTLE QUALICUM RIVER NEAR QUALICUM BEACH (08HB029)	14
FIGURE 7: WHISKY CREEK DRAINAGE.....	16
FIGURE 8: ANNIE CREEK DRAINAGE.....	18

FIGURE 9: WESTGLADE BROOK DRAINAGE	20
FIGURE 10: QUALICUM RIVER NEAR BOWSER (08HB001)	22
FIGURE 11: QUALICUM RIVER AT OUTLET OF HORNE LAKE (08HB018).....	23
FIGURE 12: QUALICUM RIVER FISH HABITAT	27
FIGURE 13: LITTLE QUALICUM RIVER MEAN MONTHLY FLOWS AT STATION 08HB029	29
FIGURE 14: WHISKY CREEK MEAN MONTHLY FLOWS	30
FIGURE 15: ANNIE CREEK MEAN MONTHLY FLOWS	31
FIGURE 16: WESTGLADE BROOK MEAN MONTHLY FLOWS	32
FIGURE 17: QUALICUM RIVER MEAN MONTHLY FLOWS AT STATION 08HB001	33
FIGURE 18: NUMBER OF WATER LICENCES	34
FIGURE 19: ANNUAL LICENCED WATER DEMAND.....	35
FIGURE 20: QUALICUM RIVER ANNUAL IRRIGATION WATER REQUIREMENTS	42

Appendices

APPENDIX A: CANADIAN CLIMATIC NORMALS	49
APPENDIX B: WATER SURVEY OF CANADA (WSC) HYDROMETRIC INFORMATION.....	52
APPENDIX C: MISCELLANEOUS FLOW RECORDS.....	63
APPENDIX D: LICENCED WATER DEMAND BY PURPOSE	66
APPENDIX E: LOW FLOW LICENCED WATER DEMAND BY DRAINAGE AREA	69
APPENDIX F: PENDING WATER LICENCE APPLICATIONS.....	71
APPENDIX G: FISH SCREENING REQUIREMENTS.....	73

1.0 INTRODUCTION

The Water Management Program's goals are to sustain a healthy water resource through anticipating and planning for water uses. Water Allocation Plans are a means of identifying water demands and ensuring that water use is compatible with the goals of a sustainable environment. The advantages are:

1. Water Managements position on water allocation decisions is available to applicants and public.
2. Response time is reduced.
3. Eliminates the need for individual studies and reports on each application.
4. Consistency of decisions are improved.
5. Specific allocation directions and decisions are defined.
6. Plans are more comprehensive.
7. Eliminates the need for referrals on individual applications.

The Vancouver Island Region developed the following policy to provide water allocation direction:

Regional Policy:

The region shall be subdivided into watershed areas and a water allocation plan shall be prepared for each watershed area. Water licence decisions will be made in accordance with approved plans.

Assessments undertaken as part of the water allocation planning process include identifying the surface water resources available, the instream requirements for fish, the existing and potential licensable water demands and providing direction regarding further water licence allocations.

Input may be sought from other agencies. Referrals go to Federal & Provincial Fisheries agencies and to Water Management in Victoria.

2.0 GENERAL WATERSHED INFORMATION

2.1 Geography and Morphology

The Qualicum River Water Allocation Plan area (see Figure 1) is located approximately one third of the way up the eastern coast of Vancouver Island. The boundaries of the area are physically defined by the Strait of Georgia, the Beaufort Ridge and the McLaughlin Ridge. The Qualicum River Water Allocation Plan area is located between the communities of Qualicum Beach, Port Alberni and Qualicum Bay. Most of the drainage flows to the northeast into the Strait of Georgia. The approximate area of the Qualicum River Water Allocation Plan is 416 Km².

The highest point in the Qualicum River Water Allocation Plan area is Mount Arrowsmith at 1819 m. This peak along with a number of smaller peaks to the north, south and west define the divide which separates the Qualicum River and the Little Qualicum River from French Creek, Englishman River, and drainages flowing into the Alberni Inlet, Stamp River and Qualicum Bay.

2.2 Climate

The Qualicum River Water Allocation Plan area has a temperate climate which is characterized by mild, wet winters and warm, dry summers. Climatic normals for the plan area have been obtained from Environment Canada, Atmospheric Environment Service (AES) stations at the Qualicum River Fish Research station and the outlet of Cameron Lake on the Little Qualicum River (see Appendix A). At the Qualicum River Fish Research station the mean daily temperature is 9.2 °C throughout the year. January is the coldest month of the year with a mean daily temperature of 2.7 °C. July is the warmest month of the year with a mean daily temperature of 16.6 °C.

Precipitation in this area is low during the summer months and high during the winter months (see also section 3.1). A lack of precipitation and high evaporation rates during the summer months along with the location of the area in the rain shadow of the Vancouver Island Mountains creates an annual moisture deficit for the area.

2.3 Geology and Groundwater

The Qualicum River Water Allocation Plan area has been shaped by a variety of physical systems. The parent materials of this area consist of glacial, fluvioglacial and marine type

sediments. Glacial activities during the Pleistocene epoch played the principal role in the region's geology depositing unconsolidated sands, gravels and tills. These deposits have also been underlain by marine deposits in areas low enough to have been affected by sea level fluctuations. Beyond the base of the Beaufort Range, the ground features are composed of sedimentary, volcanic and granitic rock surfaces. Limestone deposits can be found north and west of Horne Lake where karst topography can be observed as limestone solution caves. Areas around Horne Lake are very prone to rockfalls and avalanches. The steeper slopes within the boundaries of the Qualicum River Water Allocation Plan are also prone to mass movement. This colluvial activity has also played a role in the shaping of the landscape. (RDN, 1989)

Groundwater flow is the major source of water into and out of the Illusion Lakes and Spider Lake. Groundwater resources are known to exist in the Quadra Sands and possibly in fractured bedrock at upper elevations (RDN, 1989).

2.4 History and Development

The Coast Salish people, also known as the Pentlach Linguistic Group, used to inhabit the east coast of Vancouver Island. These people were semi-sedentary and would fish salmon at the mouths of the Little Qualicum and Qualicum Rivers. Evidence of shell middens and wood weirs at the mouths of the Little Qualicum and Qualicum Rivers have been found. The first white settlers arrived in the Qualicum River Water Allocation Plan area around 1886. They settled along the coast and near the mouths of rivers and came in search of farmsteads or employment with the forest industry.

The first known logging camps in the area were the Olympic Logging Camp and the Thompson Clark Logging Camp. These once operated on the bank of the Qualicum River. The 1908 completion of the E. & N. Railroad through Courtenay and Nanaimo also encouraged forestry and agriculture in the area.

Development in the Qualicum River Water Allocation Plan area is mainly rural, however, recreational and forestry related activities dominate. There are two fish hatcheries, the larger of the two is located on the Qualicum River and the other on the Little Qualicum River. There are major blocks of Agricultural Land Reserve (A.L.R.) land by the Little Qualicum and Qualicum Rivers. However, much of the land in A.L.R. is located within the Provincial Forest Reserve or is held privately by major logging companies.

The residential communities in the Qualicum River Water Allocation Plan area are the incorporated areas of Dashwood, Dunsmuir, Whisky Creek, and the western portion of Hilliers.

Many of the residents along the coast are retired and although the population is increasing, it is doing so at a slower rate than the siding municipality of Qualicum Beach (RDN, 1989).

2.5 Significant Drainage Areas

For the purpose of assessing water supplies for allocation demands, the watershed and drainage areas in the following table were identified and are illustrated in Figure 2.

Drainage	Area (Km ²)
Little Qualicum River (including Whisky Creek)	251.17
Whisky Creek	26.36
Annie Creek	5.36
Westglade Book	4.56
Qualicum River	145.59
Total Area	416.28

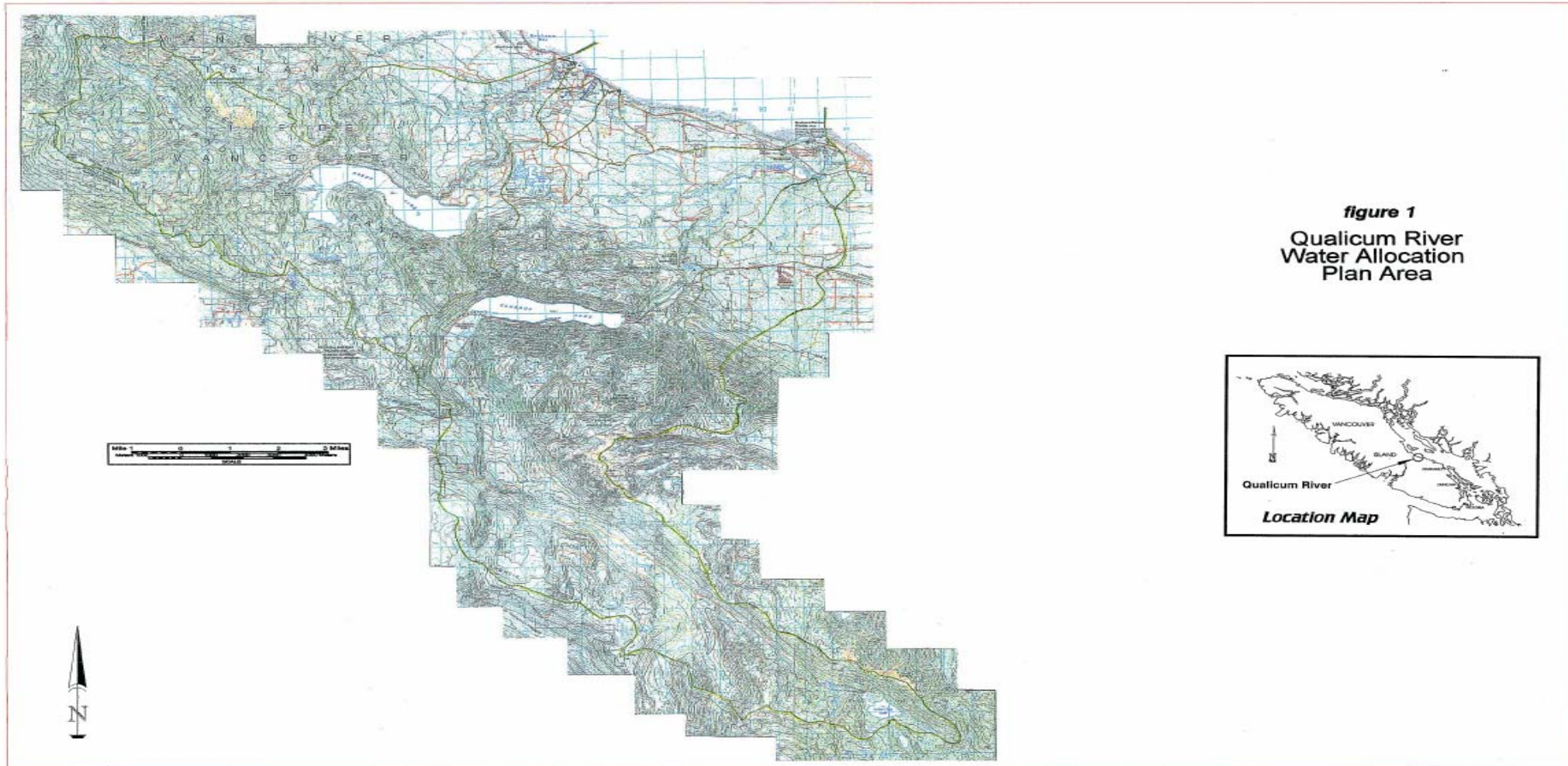

QUALICUM RIVER

WATER ALLOCATION PLAN

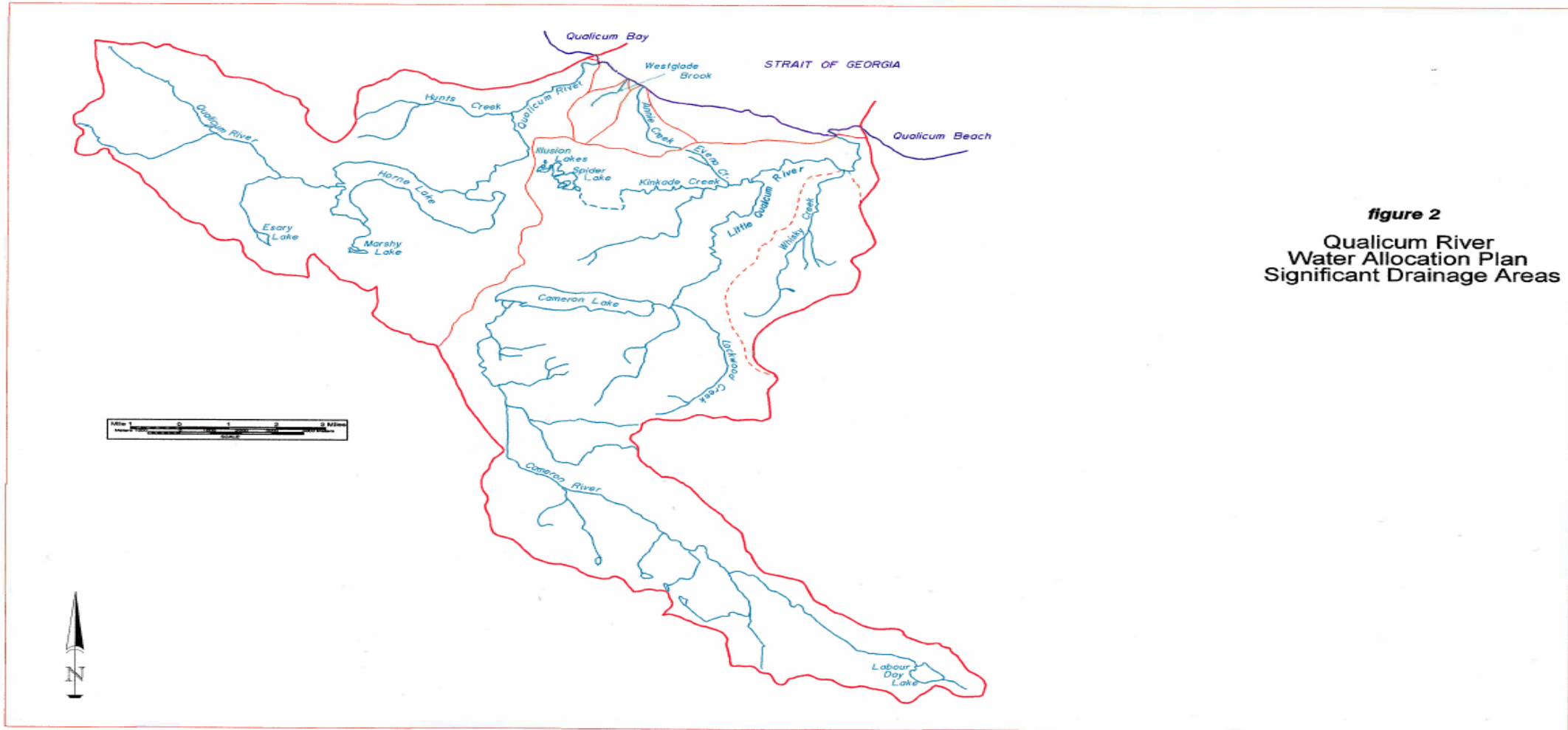

figure 2
Qualicum River
Water Allocation Plan
Significant Drainage Areas

3.0 HYDROLOGY

3.1 Precipitation

There are two Atmospheric Environment Service (AES) stations in the Qualicum River Water Allocation Plan area, the Qualicum River Fish Research station and the Cameron Lake station on the Little Qualicum River. (See Appendix A for Canadian Climatic Normals.)

The mean total annual precipitation at the Qualicum River Fish Research station is 1,293 mm. The minimum mean monthly precipitation at the Qualicum River Fish Research station is 29 mm occurring in July and the maximum mean monthly precipitation is 215 mm occurring in December. The mean number of days with measurable precipitation at the Qualicum River Fish Research station is 160, with 155 mean days of measurable rainfall and 9 mean days of measurable snowfall.

The mean total annual precipitation at the Cameron Lake station is 1,635 mm. At the Cameron Lake station, the minimum mean monthly precipitation is 32 mm occurring in July and the maximum mean monthly precipitation is 266 mm occurring in December. The mean number of days with measurable precipitation at the Cameron Lake station is 147, with 139 mean days of measurable rainfall and 14 mean days of measurable snowfall.

Figure 3 illustrates monthly precipitation normals at the Qualicum River Fish Research station and at the Cameron Lake station.

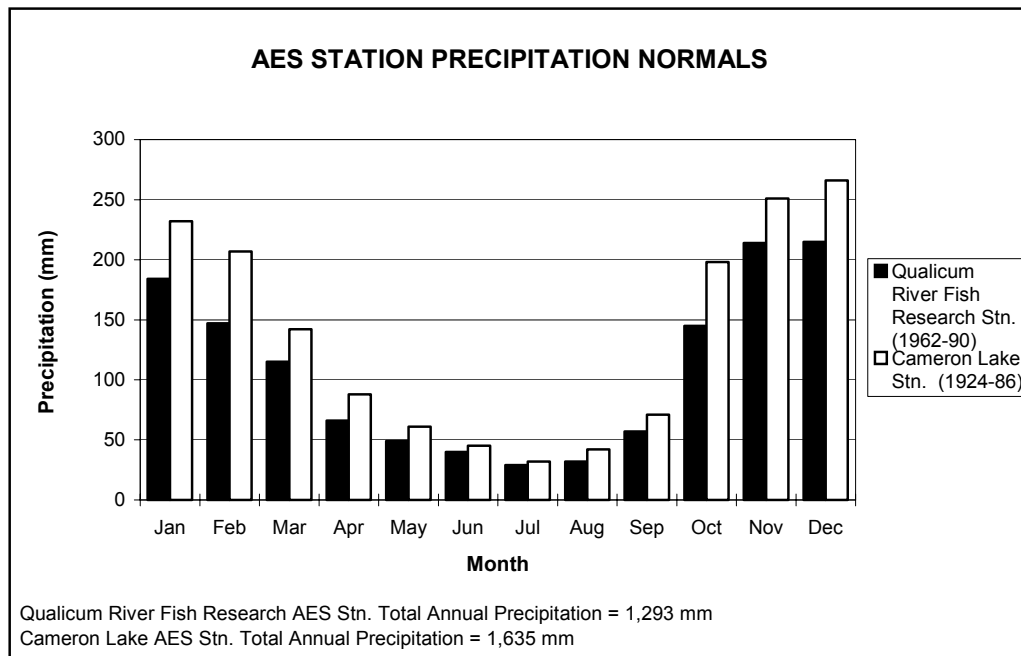

Figure 3: AES Station Precipitation Normals

The precipitation normals at the Cameron Lake station are greater than the precipitation normals at the Qualicum River Fish Research station. This is caused by the Cameron Lake station being located at a higher elevation.

3.2 Hydrometric Information

There are six Water Survey of Canada (WSC) hydrometric stations within the Qualicum River Water Allocation Plan area. Four of these have annual flow records, namely; Qualicum River near Bowser (08HB001), Little Qualicum River at outlet of Cameron Lake (08HB004), Qualicum River at outlet of Horne Lake (08HB018), and Little Qualicum River near Qualicum Beach (08HB029). For the WSC station Cameron River near Alberni (08HB019) there are flow records in February, March, August and September. For the station Horne Lake near Bowser (08HB021) there are incomplete annual lake levels. Table 2 lists the WSC Stations in the Qualicum River Water Allocation Plan area.

Table 2: Water Survey of Canada Stations Used For Regionalization					
Station Number	Station Name	Period of Record	Drainage Area (km ²)	Mean Annual Discharge (m ³ /s)	Mean 7-Day Average Low Flow (m ³ /s)
08HB001	Qualicum River near Bowser	1913-74	148	7.3	1.314
08HB004	Little Qualicum River at outlet of Cameron Lake	1913-93	135	8.67	0.937
08HB018	Qualicum River at outlet of Horne Lake	1958-62	111	6.21	0.126
08HB019	Cameron River near Alberni	1958-59	83.1		0.639
08HB021	Horne Lake near Bowser	1958-62			*0.279 m
08HB029	Little Qualicum River near Qualicum Beach	1960-86	237	11.8	1.293

* Minimum Daily Water Level in metres for 1958-61

The Water Survey of Canada hydrometric station discharge records are summarized in Appendix B.

Figure 4 illustrates the location of each WSC hydrometric station within the Qualicum River Water Allocation Plan area, the locations of the Qualicum River Fish Research AES station and the Cameron Lake AES station, and the locations of the miscellaneous flow measurement stations.

There are also miscellaneous stream flow records available from Regional Engineer's Reports related to water licences and provincial low flow monitoring studies. There are discharge records available for Cameron River, Whisky Creek, Kinkade Creek, Annie Creek, Olympic Springs (tributary to Westglade Brook), and Monitored & Regulated records for Qualicum River. The miscellaneous stream flow records are summarized in Appendix C.

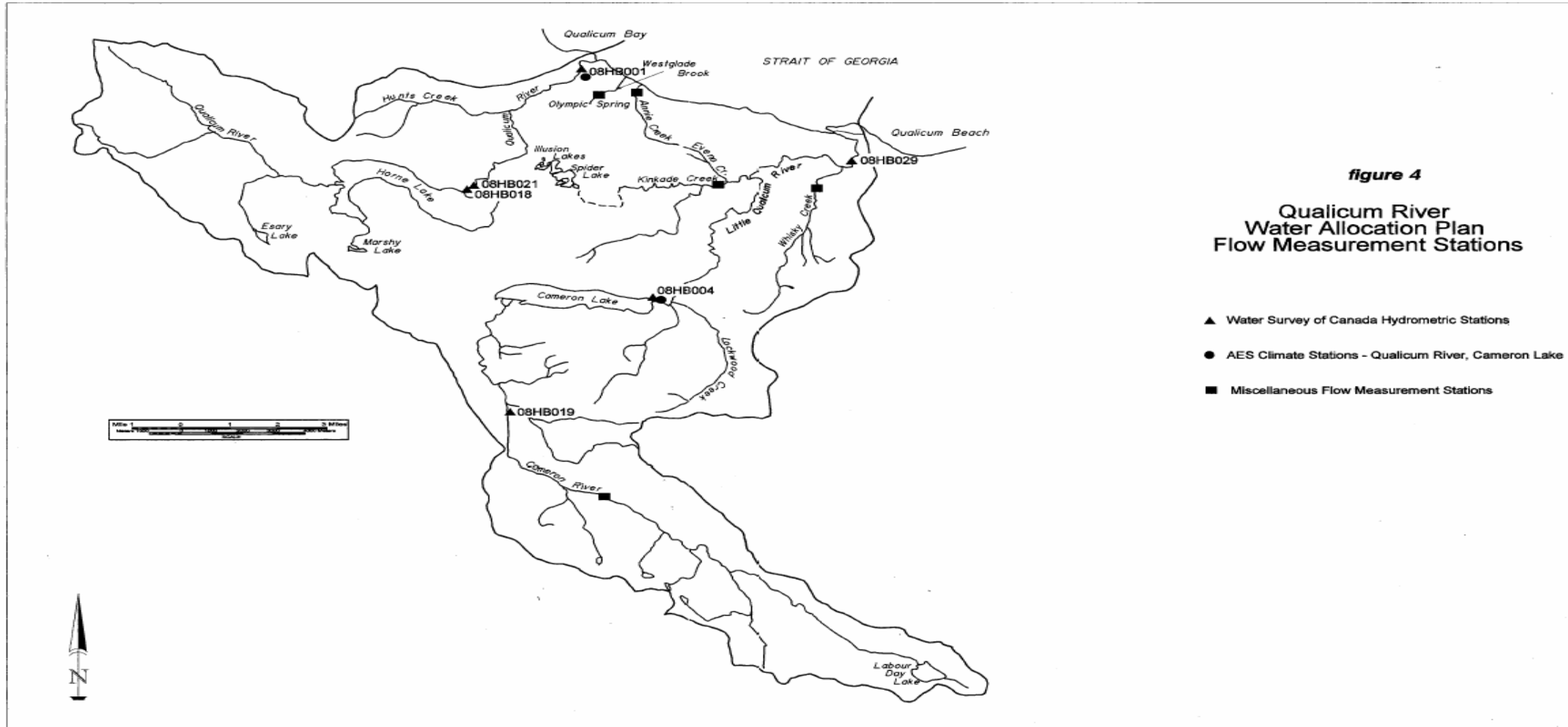

The mean monthly discharge (MMD) and the mean annual discharge (MAD) of the low elevation drainages of Whisky Creek, Annie Creek and Westglade Brook were estimated from the period of natural flow of the Little Qualicum River. Regulation of the Little Qualicum River began in 1978 by the Department of Fisheries and Oceans Canada. The discharge of the lower portion of the Little Qualicum River was calculated by subtracting the mean monthly flows of the Little Qualicum River at the Outlet of Cameron Lake(station 08HB004) from the flows recorded at the mouth of the river (station 08HB029) for the period of 1960-77 (natural records available from both stations). The discharge runoff of the lower portion of the Little Qualicum River was calculated by dividing the MMD and the MAD by the area. The estimated discharges and discharge runoffs per square kilometre are in the following table.

Table 3: Discharge and Discharge Runoff per Square Kilometre 1960-77
(litres/sec)

Station Number	Jan	Feb	Mar	Apr	May	Jun	Jul	Aug	Sep	Oct	Nov	Dec	MAD
08HB029 l/sec	20,220	16,960	14,210	11,540	12,450	9200	4610	2300	2599	9470	18,140	23,010	12,010
08HB004 l/sec	15,200	12,070	9440	8190	10,240	7810	3880	1770	1930	7810	13,960	17,350	9270
Difference l/sec	5020	4890	4770	3350	2210	1390	730	530	669	1660	4180	5660	2740
Difference l/sec/Km ²	49	48	47	33	22	14	7	5	7	16	41	55	27

To obtain a first estimate of the MMD and the MAD of Whisky Creek, Annie Creek and Westglade Brook, the above discharge runoff was multiplied by the drainage areas. Miscellaneous stream flow measurements were used to modify the estimated mean monthly discharges.

3.3 Stream Flow Estimates

3.3.1 Little Qualicum River Drainage

The drainage area of the Little Qualicum River, including Whisky Creek, is 251 Km² (96.9 mi²). Cameron Lake is located at the head of the Little Qualicum River with the Cameron River entering at the western side of the lake. The lake’s outlet into the Little Qualicum River has been regulated since 1978. Subterrain flow from Spider Lake and the Illusion Lakes is

presumed to flow into the Kinkade Creek system (Norris, 1986). A portion of Spider Lake has been separated from the main lake by a road. During the peak flow season, this portion of Spider Lake may superficially flow into Kinkade Creek. With the exception of the previous, neither one of these lakes has a surface outlet (Norris, 1986). Kinkade Creek and Whisky Creek are tributary to the Little Qualicum River. The lower third of the Little Qualicum River drainage area is below the 600m contour interval. The Little Qualicum River drainage is therefore a moderately high elevation watershed.

There are 42 years (1913-22, 1960-93) of flow records for the Little Qualicum River at Outlet of Cameron Lake and 27 years (1960-86) of flow records for the Little Qualicum River near Qualicum Beach. There are miscellaneous stream flow records for the Cameron River during 1959-63 and Kinkade Creek for September 10 and 12, 1985 and for July, August and September of 1992 (see Appendix C).

The following tables and figures summarize the WSC stations 08HB004 and 08HB029 mean monthly discharge and mean annual discharge flow estimates for the period of record on the Little Qualicum River. The discharge records have been separated into natural and regulated records. The flow in the Little Qualicum River drainage area is estimated by using the Little Qualicum River near Qualicum Beach (08HB029) WSC hydrometric station located near the mouth of the Little Qualicum River.

Table 4: Little Qualicum River at Outlet of Cameron Lake (08HB004)													
Mean Monthly and Mean Annual Discharge													
(litres/sec)													
Site	Jan	Feb	Mar	Apr	May	Jun	Jul	Aug	Sep	Oct	Nov	Dec	MAD
Natural 1913-77	13,540	11,080	8,870	8,300	9,930	8,320	4,210	1,870	2,350	8,060	13,270	15,780	8,940
Regulated 1978-93	12,710	14,380	9,840	8,630	8,000	5,440	2,300	1,310	2,020	6,060	13,940	14,130	8,240

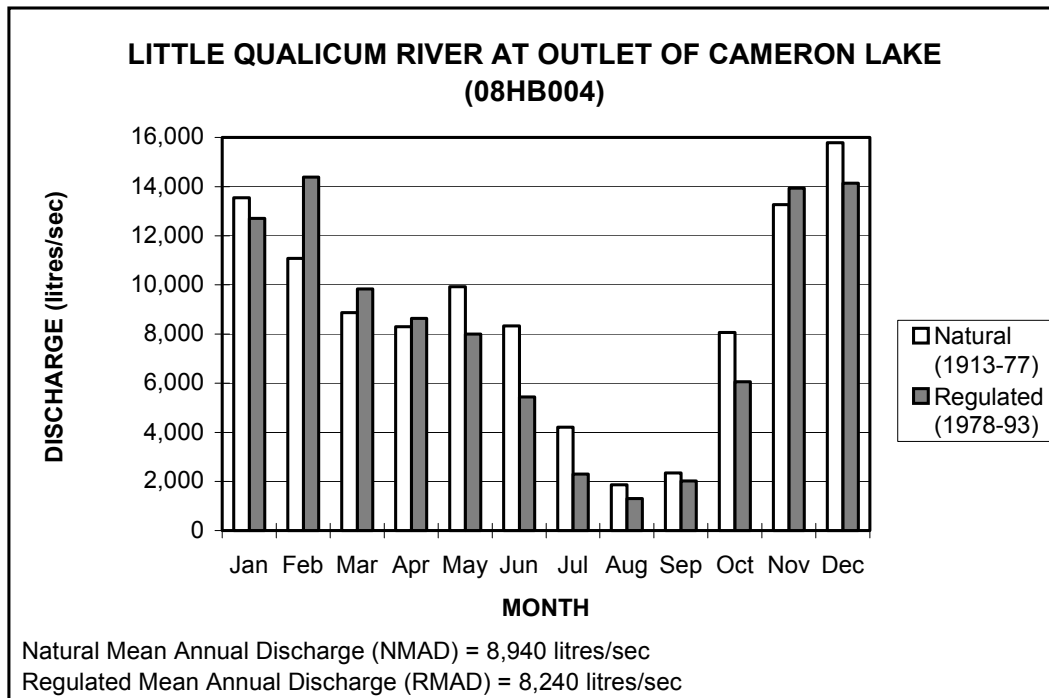

Figure 5: Little Qualicum River at Outlet of Cameron Lake (08HB004)

Site	Jan	Feb	Mar	Apr	May	Jun	Jul	Aug	Sep	Oct	Nov	Dec	MAD
Natural 1960-77	20,220	16,960	14,210	11,540	12,450	9,200	4,610	2,300	2,600	9,470	18,140	23,010	12,010
Regulated 1978-86	16,840	20,550	14,480	10,620	10,200	6,840	3,600	1,590	3,510	9,360	18,750	20,620	11,350

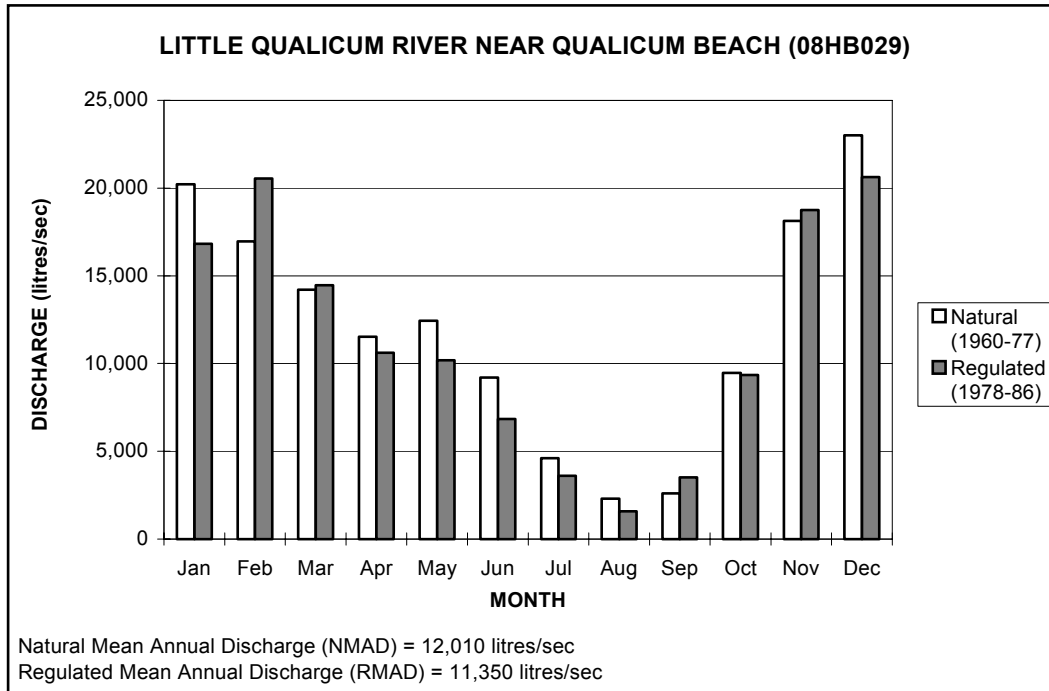

Figure 6: Little Qualicum River near Qualicum Beach (08HB029)

The flow from higher elevations above the Little Qualicum River at Outlet of Cameron Lake (08HB004) is greater than from the lower elevation portion of the Little Qualicum River below Cameron Lake.

3.3.1.1 Whisky Creek Drainage

The estimated drainage area of Whisky Creek is 26 Km² (10.17 mi²). Whisky Creek is tributary to the Little Qualicum River above the Little Qualicum River near Qualicum Beach (08HB029) WSC hydrometric station. The lower two thirds of the Whisky Creek drainage area are below the 200 m contour interval. The Whisky Creek drainage is therefore a low elevation watershed.

There are miscellaneous low flow records for May 22 of 1980, September 5 and 10 of 1985, July 21 and 26, August 17 and 23, September 1, 10 and 27, and October 13 of 1993 (see Appendix C).

The discharge runoffs per square kilometre recorded on Whisky Creek are approximately 10% of the discharge runoffs per square kilometre estimated for the lower portion of the Little Qualicum River drainage. Therefore the Whisky Creek discharge runoffs per square kilometre during the low flow months of May to September were adjusted to 10% of the lower portion of the Little Qualicum River discharge. The discharges for October to April were adjusted higher to redistribute the flow to the higher flow months.

The following table and figure illustrate the mean monthly discharge and mean annual discharge flow estimates.

Table 6: Whisky Creek Mean Monthly and Mean Annual Discharge												
(litres/sec)												
Jan	Feb	Mar	Apr	May	Jun	Jul	Aug	Sep	Oct	Nov	Dec	MAD
1479	1464	1415	1052	57	36	19	14	17	611	1269	1644	710

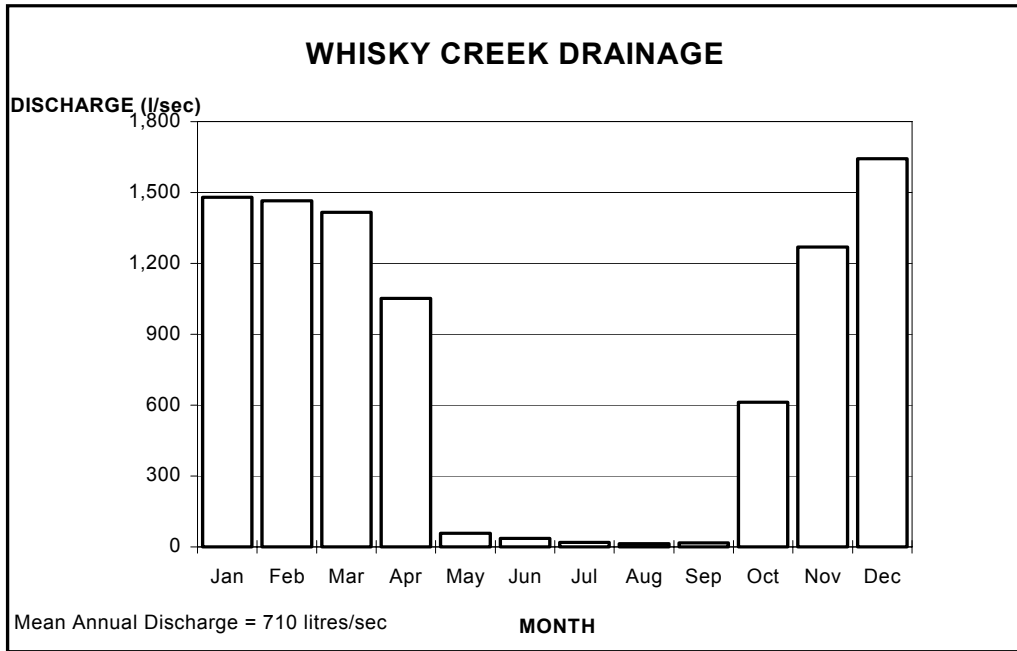

Figure 7: Whisky Creek Drainage

3.3.2 Annie Creek Drainage

The estimated drainage area of Annie Creek is 5.4 Km² (2.07 mi²). The Annie Creek drainage is below the 200 m contour interval; it is therefore a low elevation watershed.

There are low flow records for Annie Creek on August 29, September 11 and 12 of 1985 and July, August and September of 1992 (see Appendix C).

The discharge runoffs per square kilometre recorded on Annie Creek are approximately 10% of the discharge runoffs per square kilometre estimated for the lower portion of the Little Qualicum River drainage. Therefore the Annie Creek discharge estimates were adjusted similar to Whisky Creek.

The following table and figure illustrate the mean monthly discharge and the mean annual discharge flow estimates.

Table 7: Annie Creek Mean Monthly and Mean Annual Discharge												
(litres/sec)												
Jan	Feb	Mar	Apr	May	Jun	Jul	Aug	Sep	Oct	Nov	Dec	MAD
301	297	288	214	12	7	4	3	4	124	258	334	144

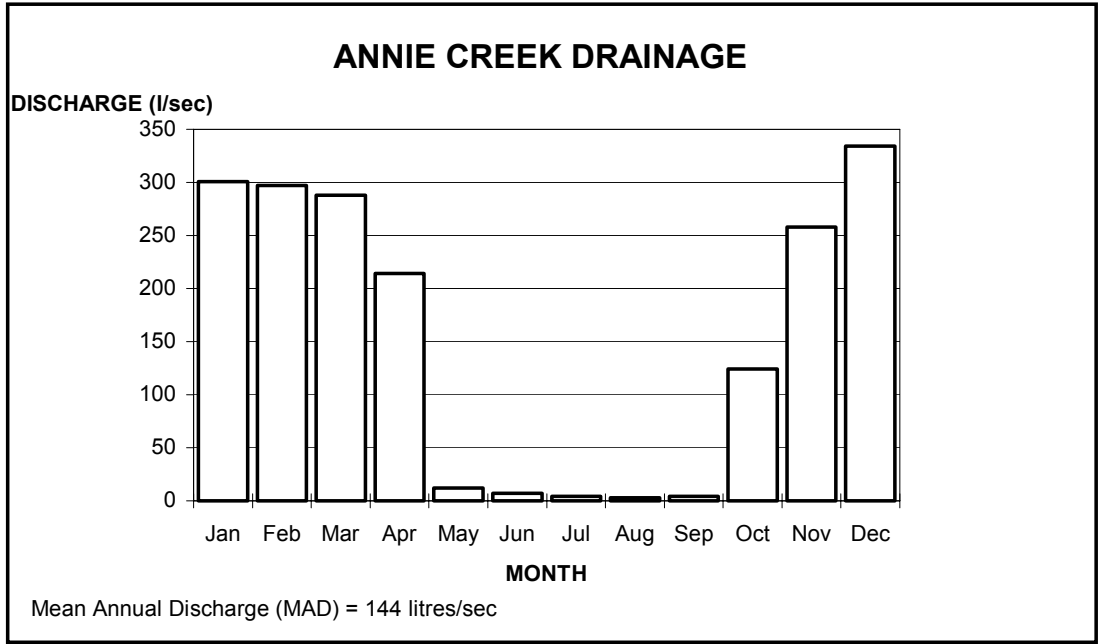

Figure 8: Annie Creek Drainage

3.3.3 Westglade Brook Drainage

Westglade Brook drainage has an estimated area of 4.6 Km² (1.76 mi²). Olympic Spring is tributary to Westglade Brook. The Westglade Brook drainage is below the 200 m contour interval; it is therefore a low elevation watershed.

There are stream flow records for Olympic Spring for August 17, 22, September 2, 9, 23, 30, and October 14, 1983 (see Appendix C).

The discharge runoffs per square kilometre recorded on Westglade Brook are approximately 10% of the discharge runoffs per square kilometre estimated for the lower portion of the Little Qualicum River drainage. Therefore the Westglade Brook discharge estimates were adjusted similar to Whisky Creek.

The following table and figure illustrate the mean monthly discharge and the mean annual discharge flow estimates.

Table 8: Westglade Brook Mean Monthly and Mean Annual Discharge												
(litres/sec)												
Jan	Feb	Mar	Apr	May	Jun	Jul	Aug	Sep	Oct	Nov	Dec	MAD
256	254	245	182	10	6	3	2	3	106	220	285	123

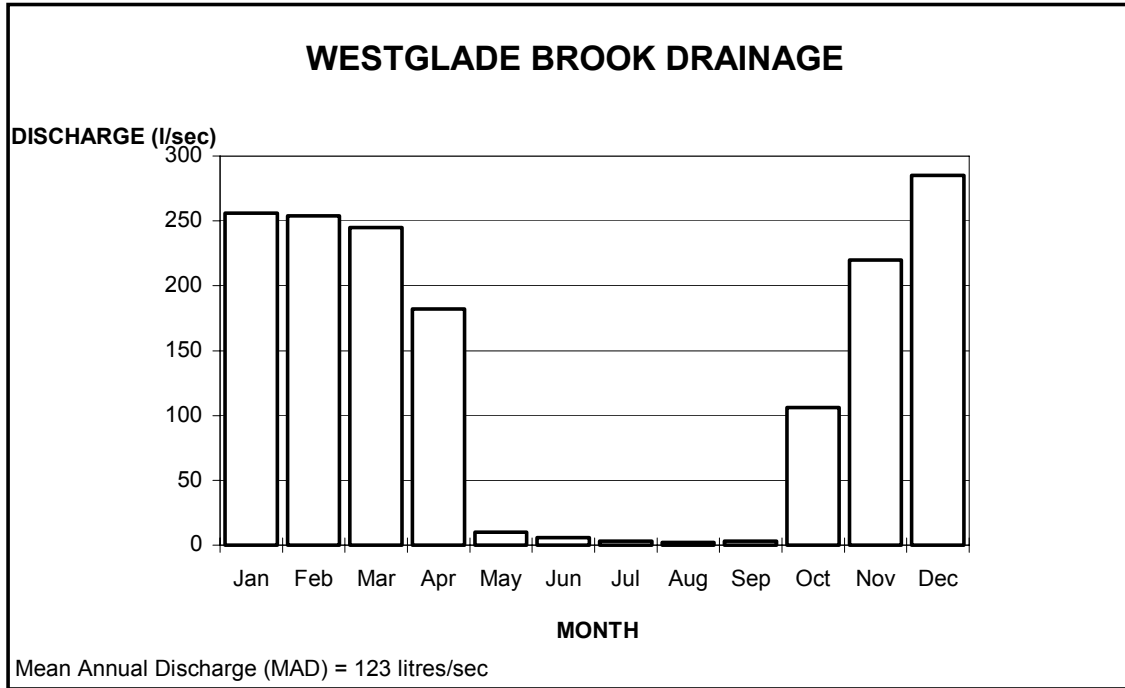

Figure 9: Westglade Brook Drainage

3.3.4 Qualicum River Drainage

The Qualicum River drainage area is 146 Km² (56.17 mi²). Horne Lake is on the Qualicum River and its outlet into the Qualicum River has been regulated since 1963. Hunts Creek was tributary to the Qualicum River but has been diverted in a canal parallel to the Qualicum River and into the ocean in 1963.

There are 29 years (1913-22, 1956-74) of flow records for the Qualicum River near Bowser (08HB001) and 5 years (1958-62) of flow records for the Qualicum River at Outlet of Horne Lake (08HB018). There are also Monitored & Regulated records for the Qualicum River at the outlet of Horne Lake for 1985 to 1996 (see Appendix C).

The following tables and figures summarize the WSC stations 08HB001 and 08HB018 mean monthly discharge and mean annual discharge flow estimates for the period of record on the Qualicum River. The discharge records have been separated into natural and regulated records. The flow in the Qualicum River drainage area is estimated by using the Qualicum River near Bowser (08HB001) WSC hydrometric station located near the mouth of the Qualicum River.

Table 9: Qualicum River near Bowser (08HB001)													
Mean Monthly and Mean Annual Discharge													
(litres/sec)													
Site	Jan	Feb	Mar	Apr	May	Jun	Jul	Aug	Sep	Oct	Nov	Dec	MAD
Natural 1913-62	17,600	14,480	11,070	9,210	6,070	4,050	2,070	1,370	2,000	6,340	9,610	16,210	7,530
Regulate d 1963- 74	11,090	11,760	7,530	6,660	5,540	3,540	2,670	2,700	6,040	8,000	9,070	9,830	7,080

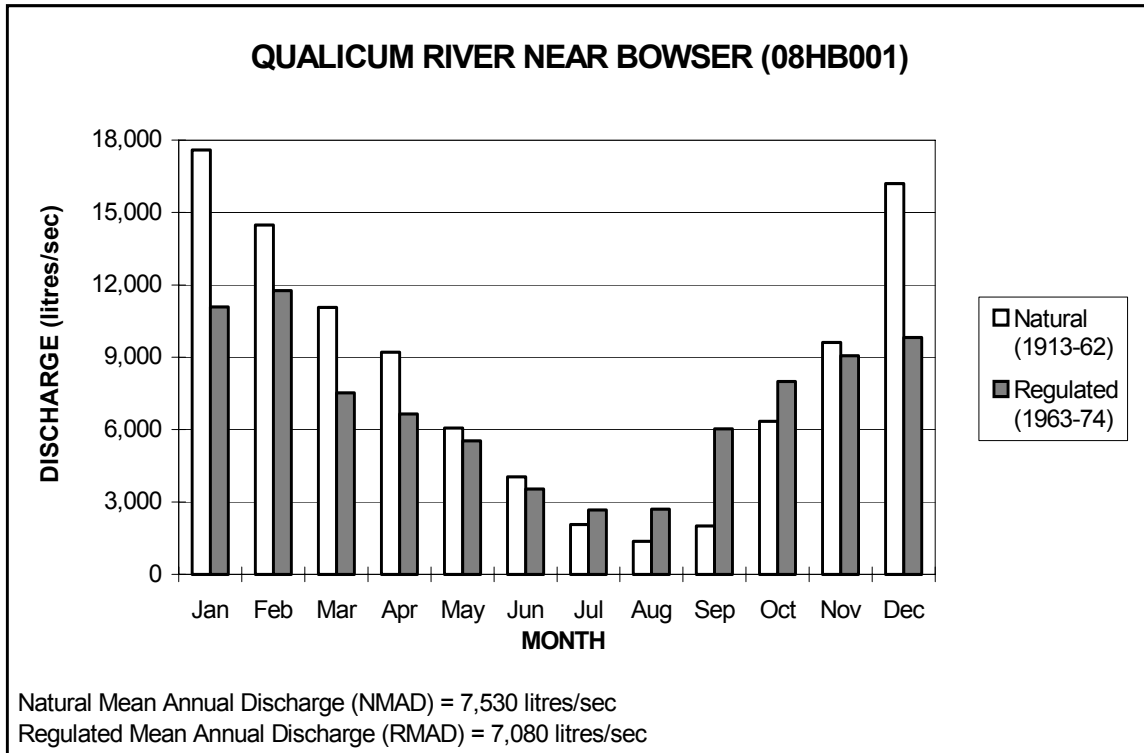

Figure 10: Qualicum River near Bowser (08HB001)

Table 10: Qualicum River at Outlet of Horne Lake (08HB018) Mean Monthly and Mean Annual Discharge (litres/sec)													
Site	Jan	Feb	Mar	Apr	May	Jun	Jul	Aug	Sep	Oct	Nov	Dec	MAD
Natural 1958-62	13,600	10,600	6,660	7,070	5,950	2,640	852	197	350	2,910	6,920	13,800	6,210

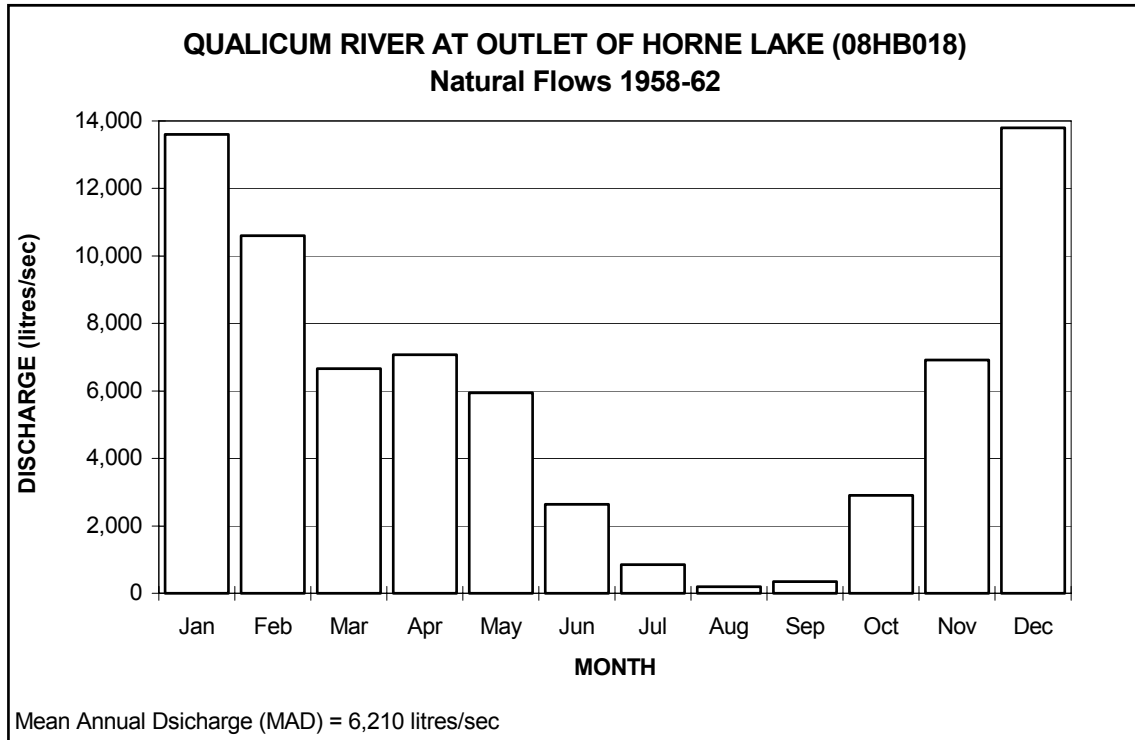

Figure 11: Qualicum River at Outlet of Horne Lake (08HB018)

3.3.5 Low Flows

The minimum monthly discharge flows occur predominantly in August and September but there are occurrences in June, July and October. The minimum mean monthly discharge (MMD) occurs in August.

The 7-day average low flows occur predominantly in August and September but there are occurrences during July and October and rarer occurrences during May, June and December. (See Appendix B for 7-day average low flows for stations 08HB004, 08HB029, 08HB001 and 08HB018.)

The following table illustrates a summary of the drainage areas, the mean annual discharge (MAD), the minimum mean monthly discharge (Min MMD), and the mean 7-Day average low flow of the significant drainages in the Qualicum River Water Allocation Plan area.

Table 11: Drainage Area, MAD, Min MMD and Mean 7-Day Average Low Flow (litres/sec)				
Significant Drainage	Drainage Area (Km ²)	MAD (litres/sec)	Min MMD (litres/sec)	Mean 7-Day Avg. Low (litres/sec)
Little Qualicum River	*251.17	11,800	2,050	1,293
Whisky Creek	26.36	710	14	
Annie Creek	5.36	144	3	
Westglade Brook	4.56	123	2	
Qualicum River	145.59	7,300	1,950	1,314

* Little Qualicum River significant drainage area includes Whisky Creek drainage area of 26.36 Km².

3.4 Lake Information

The following table summarizes information available for significant lakes in the plan area.

Table 12: Lake Information				
Lake	Drainage	Surface Area (ha)	Volume (dam ³)	Mean Depth (m)
Cameron Lake	Little Qualicum River	477.50	133,504	28
Horne Lake	Qualicum River	848.23	252,000	29.8
Spider Lake	Kinkade Creek/Little Qualicum River	57.51	1795	4.48
Illusion Lake	Kinkade Creek/Little Qualicum River	6.70	133	2.0

The surface area, volume and mean depths of Cameron Lake, Horne Lake, Spider Lake and Illusion Lake were obtained from bathymetric surveys.

Information regarding summer time evaporation rates was unavailable but it is assumed that the net loss is approximately 0.3 m (1 ft) over the surface of the water body.

4.0 INSTREAM FLOW REQUIREMENTS

Maintaining the natural stream environment and instream uses is of paramount importance for present and future generations. Maintaining water for the fisheries resource is a key factor in maintaining instream flow requirements for water quality recreational, aesthetic and cultural values. The Ministry of Environment Provincial policy is:

In situations where a water allocation decision will significantly impact instream uses of water, the comptroller or regional water manager may refuse the application or include water licence conditions to protect the instream use.

Instream fisheries flow requirements are based on a provincially modified version of the Tennant (Montana) Method.

Table 13: Modified Tennant (Montana) Method Instream Flow Requirements

Flows	Description
30-60% MAD	Excellent spawning/rearing
20-30% MAD	Good spawning/rearing
10-20% MAD	Fair spawning/rearing
5-10% MAD	Poor spawning/rearing
>5% MAD	Severely degraded spawning/rearing

In drainages where fish are present, the minimum flow required to sustain the fisheries resource for fair spawning and rearing habitat is 10% of the Mean Annual Discharge (MAD). Therefore, the Regional policies to implement the Provincial policy are:

The minimum flow required to sustain the fisheries resources for spawning and rearing is 10% of the Mean Annual Discharge (MAD); unless a more rigorous analysis indicates a different minimum flow requirement.

For streams where the natural mean monthly flow falls below 10% of the MAD, extractive licensed demands should only be allowed for the period of months when the mean monthly flow is above 60% of the MAD.

For streams where the mean 7-day average low flow falls below 10% of the MAD, extractive demands should only be allowed for the period of months when the mean

monthly flow is above 60% of the MAD. Where the mean 7-day average low flow remains above 10%, then the 7-day low flow amount above 10% MAD is available

Withdrawals from natural water bodies (lakes, ponds, swamps and marshes) supporting natural fisheries resources shall not reduce the shoal area more than 10%.

Most of the streams in the Qualicum River Water Allocation Plan area are naturally limiting to fish habitat and, therefore, fish survival. Figure 12 illustrates fish habitat within the plan area.



4.1 Little Qualicum River Instream Requirements

The Little Qualicum River drainage supports both resident fish and anadromous fish. This drainage supports spawning and rearing of Sockeye, Coho, Chum, Kokanee and Dolly Varden salmon, Bass, Steelhead, sea-run Cutthroat, and Rainbow trout. Illusion Lakes and Spider Lake support small mouth Bass. Labour Day Lake, at the head of the Cameron River, supports Rainbow Trout.

The Department of Fisheries and Oceans Canada operates a fish hatchery near the mouth of the Little Qualicum River, before Whisky Creek joins the Little Qualicum River.

The minimum flow required to support the fish resource in the Little Qualicum River was determined in negotiations between the Department of Fisheries and Oceans Canada (DFO), Fish and Wildlife and Water Management of Ministry of Environment (MoE) in 1979. A water licence was issued to DFO to store water in Cameron Lake (1978) to maintain a flow of 1,274 litres/sec (45 cfs) in the spawning and rearing channels plus a flow of 1,104 litres/sec (39 cfs) in the adjoining natural channels. Therefore a more rigorous analysis indicated that the flow required to support the fish resource is 2,378 litres/sec (84 cfs).

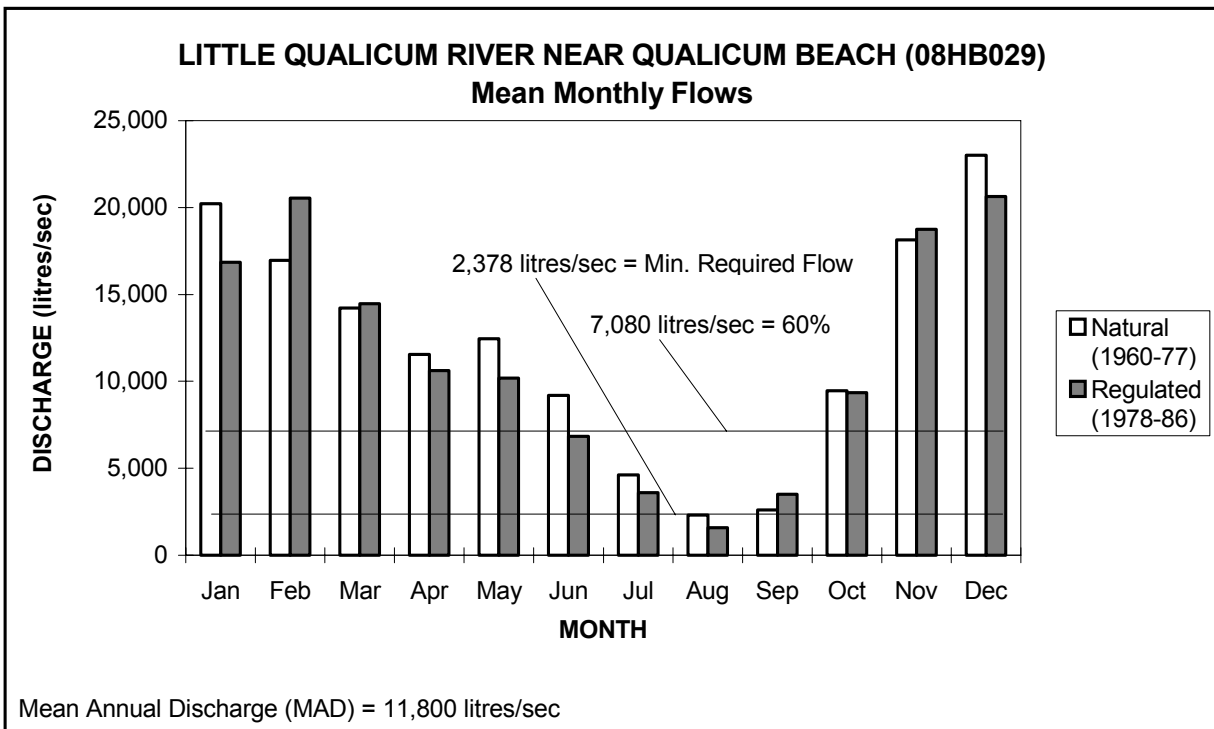

Figure 13: Little Qualicum River Mean Monthly Flows at Station 08HB029

Figure 13 illustrates that the regulated flow in August is below the minimum flow required to support the fish resource. Therefore water is only available for rural, residential domestic use unless storage is developed. Otherwise, water is only available for extractive use during the months of October through May when the mean monthly discharge is above the 60% MAD. No water is available from the Little Qualicum River when the flow is below 60% MAD or 7,080 litres/sec. The estimated volume of water available from October through May is 168,343 dam³.

4.1.1 Whisky Creek Instream Requirements

Whisky Creek drainage supports resident fish and anadromous fish. Whisky Creek drainage supports Coho salmon, sea-run and resident Cutthroat and Brown trout.

Figure 14 illustrates that the estimated mean monthly flow in Whisky Creek falls below 10% of the mean annual discharge (MAD) during the months of May through September. Water is therefore only available for extractive use during the months of October through April when the mean monthly discharge is above 60 % MAD. No water is available from Whisky Creek

when the flow is below 60% MAD or 426 litres/sec. The estimated volume of water available from October through April is 15,546 dam³.

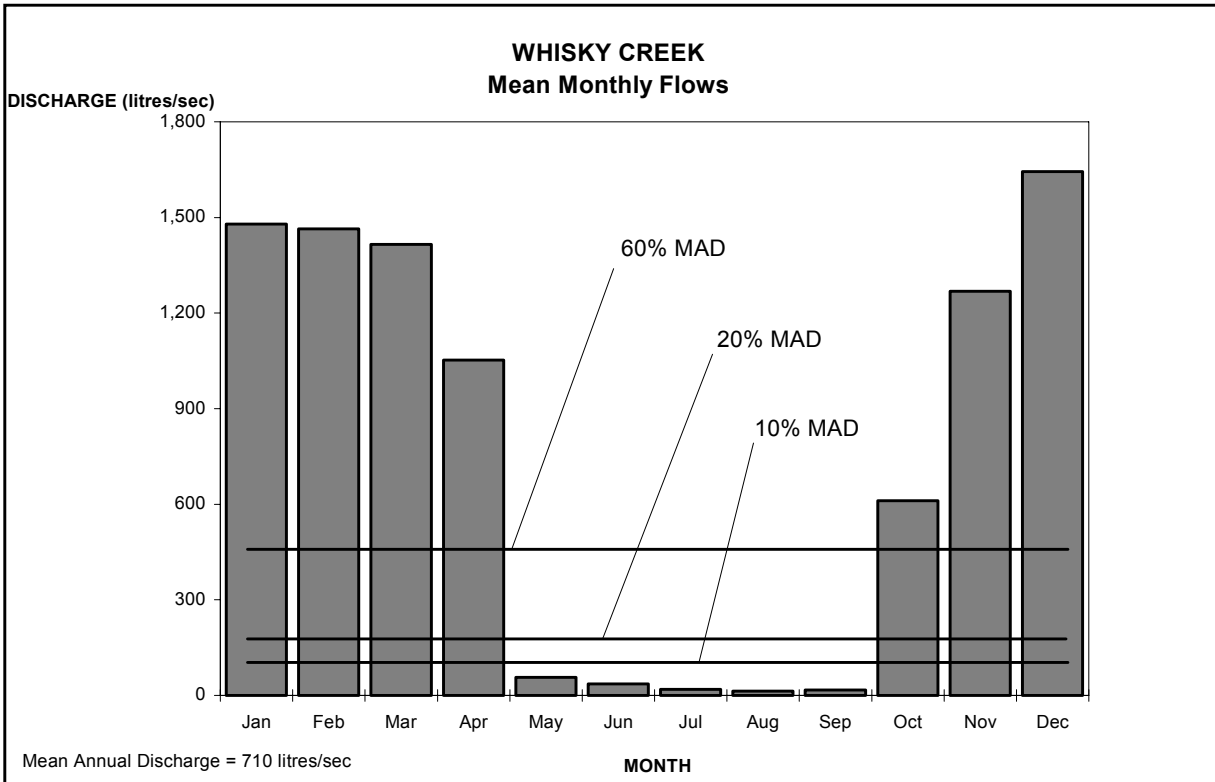

Figure 14: Whisky Creek Mean Monthly Flows

4.2 Annie Creek Instream Requirements

Annie Creek drainage supports anadromous fish including Coho Salmon and sea-run Cutthroat Trout.

Figure 15 illustrates that the estimated mean monthly flow in Annie Creek falls below 10% of the mean annual discharge (MAD) during the months of May through September. Water is therefore only available for extractive use during the months of October through April when the mean monthly discharge is above 60% MAD. No water is available from Annie Creek when the flow is below 60% MAD or 86 litres/sec. The estimated volume of water available from October through April is 3,164 dam³.

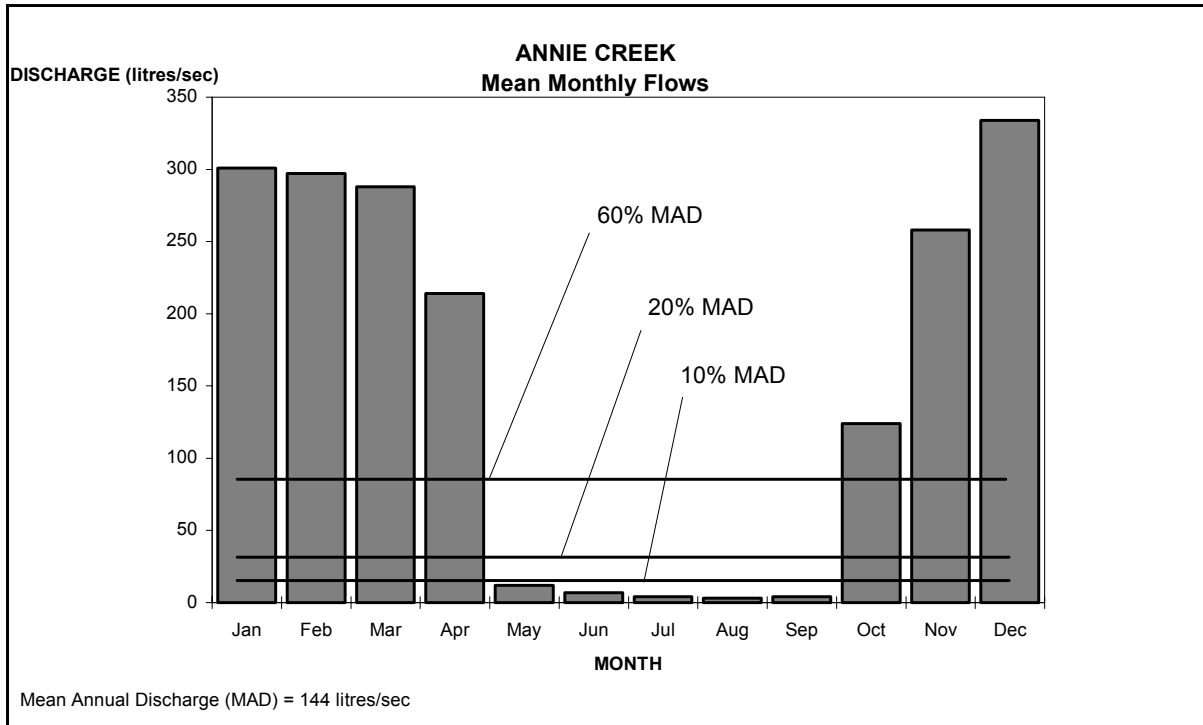

Figure 15: Annie Creek Mean Monthly Flows

4.3 Westglade Brook Instream Requirements

Fish have been observed in Westglade Brook. The number and type of fish have not been documented and therefore are not noted in Figure 12.

Figure 16 illustrates that the estimated mean monthly flow in Westglade Brook falls below 10% of the mean annual discharge (MAD) during the months of May through September. Water is therefore only available for extractive use during the months of October through April when the mean monthly discharge is above 60% MAD. No water is available from Westglade Brook when the flow is below 60% MAD or 74 litres/sec. The estimated volume of water available from October through April is 2,694 dam³.

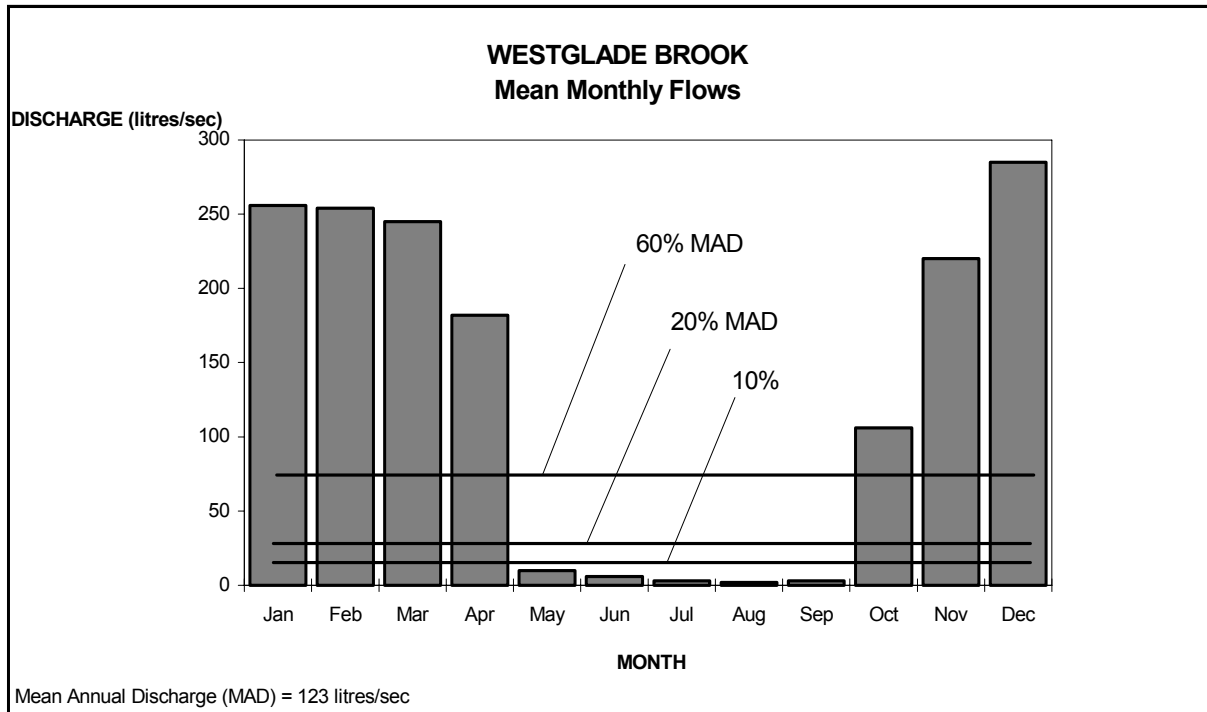

Figure 16: Westglade Brook Mean Monthly Flows

4.4 Qualicum River Instream Requirements

The Qualicum River drainage supports both resident and anadromous fish. The Qualicum River drainage supports spawning and rearing of Kokanee, Sockeye, Coho, Pink, Chum and Chinook salmon, sea-run Cutthroat, and Steelhead trout. Horne Lake supports Coho and Kokanee salmon, sea-run and resident Cutthroat, Steelhead and Rainbow trout.

The Department of Fisheries and Oceans Canada (DFO) operates a fish hatchery near the mouth of the Qualicum River. The flows from the outlet of Horne Lake are completely controlled by DFO to optimize flows for the fish resource.

A more rigorous analysis by DFO determined that the optimum flow required to support the fish resource in the Qualicum River is:

- 7,079 litres/sec (250 cfs) between September 1 and January 10
- 5,663 litres/sec (200 cfs) between January 10 and June 15
- 1,416 litres/sec (50 cfs) between June 15 and September 1.

The following figure illustrates the instream fish flow requirements in the Qualicum River.

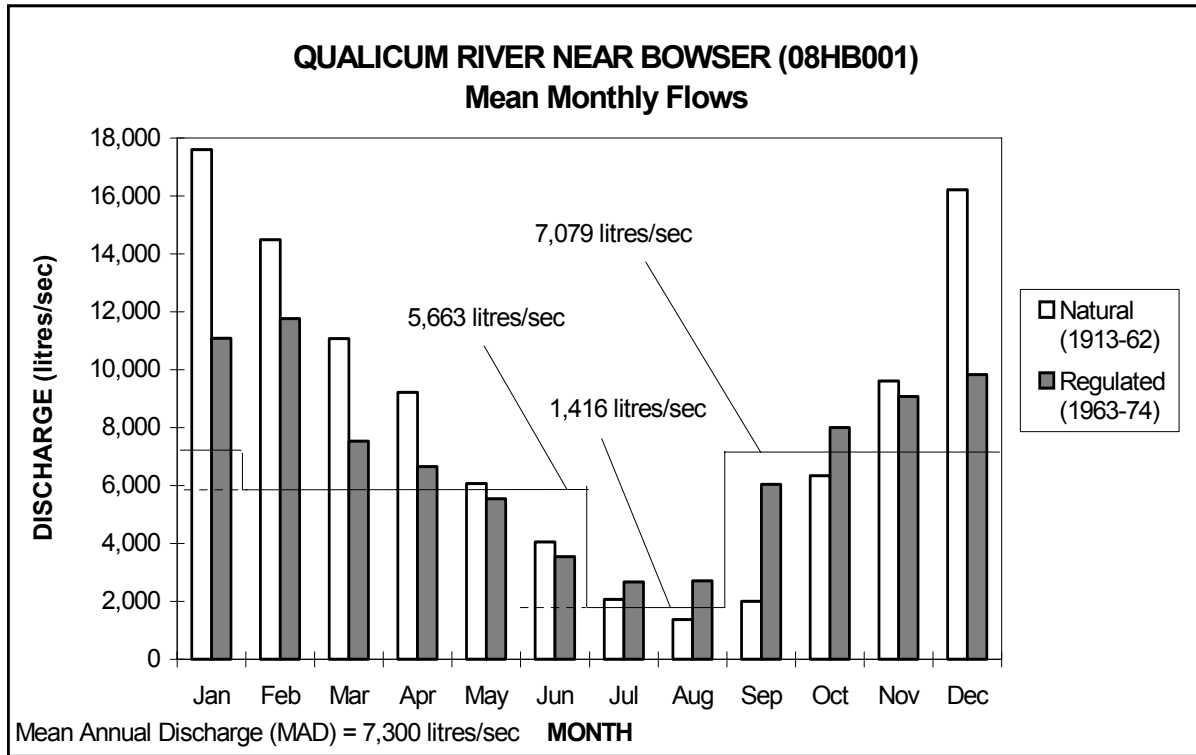

Figure 17: Qualicum River Mean Monthly Flows at Station 08HB001

In their licence, DFO is required to supply 283 litres/sec (10 cfs) for other licenced water uses when necessary.

Figure 17 illustrates that the regulated flows in May, June, and September are below the optimum flow required to support the fish resource. Water is available for storage during the months of October through April. The estimated volume of water available from October through April is 48,073 dam³.

5.0 WATER DEMAND

5.1 Licenced Demand

There are currently (June 1996) 65 water licences within the Qualicum River Water Allocation Plan area. Figure 18 illustrates the number and percentage of water licences issued for each purpose for streams within the plan area.

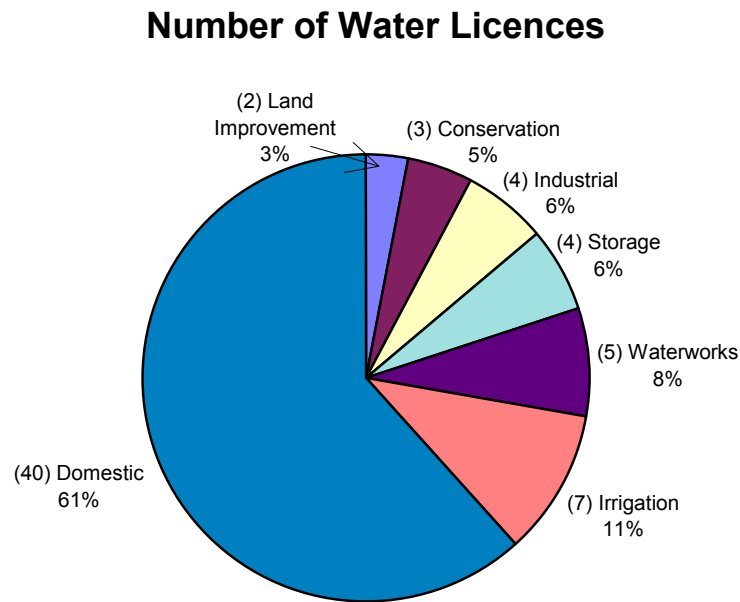

Figure 18: Number of Water Licences

There are 40 water licences (61%) issued for domestic purposes for rural residential demands. There are 7 licences for irrigation purposes, 5 licences for waterworks purposes, 4 licences for storage purposes, 4 licences for industrial purposes, 3 licences for conservation purposes, and 2 licences for land improvement purposes.

The estimated average annual licenced water demand and low flow water demand is of greater significance to water management than the actual number of licences per purpose. The total estimated average annual licenced water demand for the plan area is 442,191.31 dam³. Figure 19 illustrates the estimated average annual licenced water demand and percentage for each purpose under which water licences have been issued within the plan area.

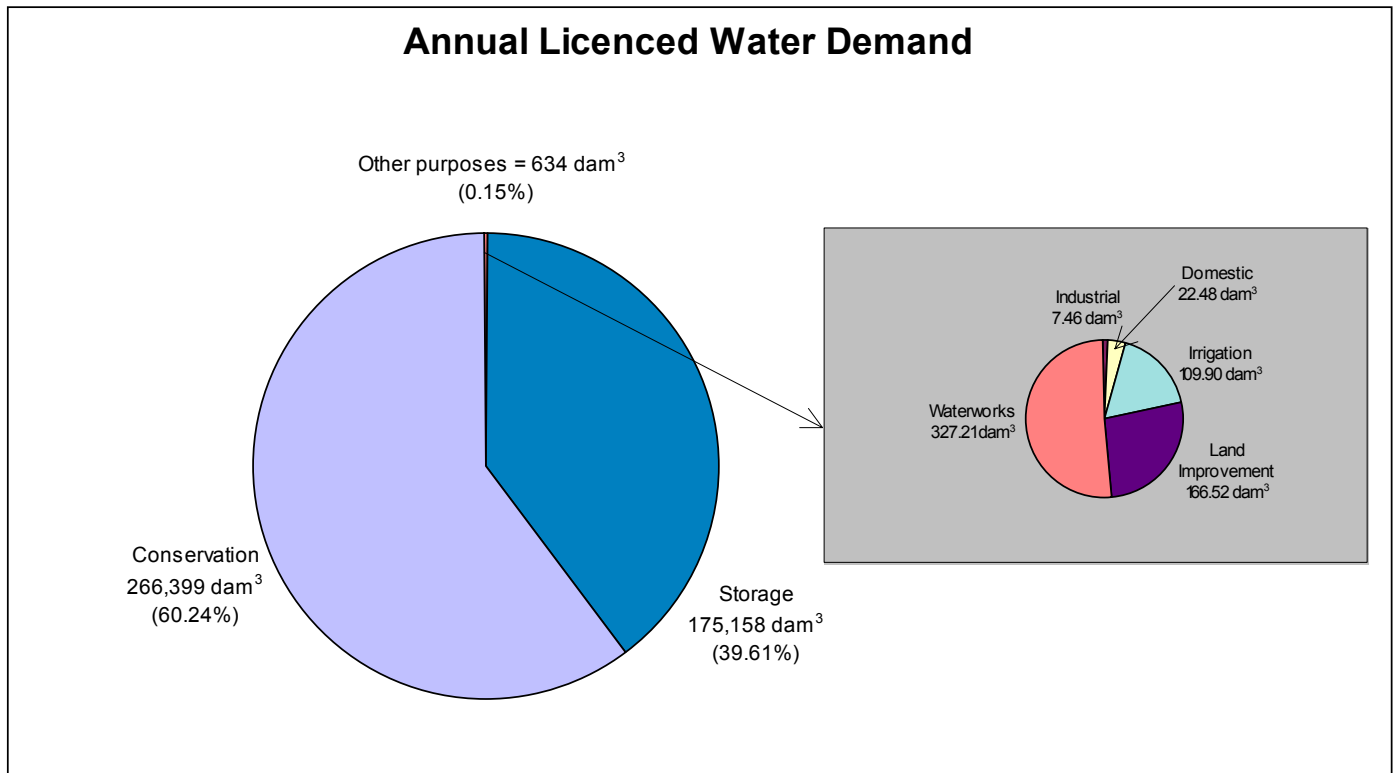

Figure 19: Annual Licenced Water Demand

The greatest percentage of the total annual water demand (60.24%) is for conservation purposes. The second largest annual water demand in the plan area is for storage purposes (39.61%), followed by municipal waterworks purposes (0.07%), land improvement purposes (0.04%), irrigation purposes (0.02%), domestic purposes (0.01%), and industrial purposes (0.0012%). Table 14 summarizes these annual water demands (see Appendix D).

PURPOSE	NUMBER OF LICENCES	QUANTITY LICENCED	ANNUAL DEMAND (dam ³)*
Industrial	4	4500 GD	7.46
Domestic	40	27,100 GD	22.48
Irrigation	7	89.1 acft	109.90
Land Improvement	2	135 acft	166.52
Municipal Waterworks	5	394,500 GD	327.21

QUALICUM RIVER

WATER ALLOCATION PLAN

Storage	4	142,001.17 acft	175,158.44
Conservation	3	215,970 acft	266,399.30
Total	65	-	442,191.31

* Assumes that industrial demands are assumed to be uniform demands over the year and the licenced volume is multiplied by 365 to determine the total annual demand. Domestic and municipal waterworks demands are the authorized maximum daily licenced divided by 2 to estimate the average daily demand and multiplied by 365 day to determine the annual demand. Irrigation, land improvement, storage and conservation licenced demands are the total annual licenced volumes.

The low flow licenced water demand can be critical between competing water uses and instream flow requirements to maintain the fish resources. The estimated low flow licenced demand for each identified drainage area and for other drainages in the Qualicum River Water Allocation Plan area is summarized in Table 15 (see Appendix E).

DRAINAGE AREA	LOW FLOW WATER DEMAND*	
	litres/second	dam ³
Little Qualicum River	28.90	346.39
Whisky Creek	3.92	61.78
Annie Creek	0.18	2.90
Westglade Brook	3.55	55.99
Qualicum River	-22,525.18**	-175,157.00**
Total	-22,488.63	-174,689.94

* Assumes that irrigation and industrial demands are totally withdrawn over a 90 day period, domestic and municipal waterworks demands are the authorized licenced maximum daily for 90 days, and land improvement and conservation are non-consumptive and therefore have no demand. A negative number indicates that licenced storage volume is in excess of the licenced demand over 90 days.

** Most of the licenced storage volume in Horne Lake has never been developed due to flooding conflicts.

5.2 Projected Demand

There are three pending water licence applications as of May 1996. The potential annual water demand of these existing applications totals 1,290.27 dam³ and includes 0.62 dam³ (0.502 acft) for land improvement (replace swamp by ponds) purpose, 39.81 dam³ (24,000 GD) for industrial (fish pond) purpose, and 1,249.84 dam³ (1,506,849 GD) for municipal waterworks purpose. The pending water licence applications within the plan area are summarized in Appendix F.

The majority of future water demands are foreseen to be similar to existing licenced water demands. Waterworks, domestic, industrial , irrigation and land improvement licences will increase in number as the population within the Qualicum River Water Allocation Plan area increases. Likewise, conservation demands will increase as the public participates to preserve and restore fish and wildlife habitat from urban encroachment and habitat destruction. Storage of winter high flows will become necessary to support water requirements during the summer low flow period.

6.0 CONCLUSIONS and RECOMMENDATIONS

Three of the drainage areas in the Qualicum River Water Allocation Plan area experience a five month low flow period below 60% MAD from May through September in which water is unavailable for extractive purposes. The Little Qualicum River experiences a four month low flow period from June through September, and the Qualicum River experiences a five month low flow period from May through September.

High flow periods in which mean monthly flows are greater than 60% of the mean annual discharge occur in most streams within the plan area from October through April. The high flow period in the Little Qualicum River and the Qualicum River is from October through May and October through April respectfully. Therefore there is considerable flow available for part of the year to develop supporting storage for water demands during the low flow months.

All significant streams within the plan area, with the exception of Westglade Brook, support an important and varied fish resource. Anadromous fish such as salmon, Steelhead and sea-run Cutthroat trout use these streams to spawn and rear their offspring. As well, resident fish such as Kokanee Salmon, Bass, Rainbow, and Cutthroat trout spend their entire lives in certain streams and lakes within the plan area. Despite the relative abundance of fish and fish habitat, flows in most of the streams within the plan area are naturally limiting to fish production and maintenance of fish habitat. In order to protect and maintain the fish resources, storage development will be required on all streams to support further extractive water demands during the low flow periods (May/June through September). The mainstems of the Little Qualicum River and the Qualicum River are excluded as storage is already provided in Cameron Lake and Horne Lake respectively.

Flows in the mainstem of the Little Qualicum River are adequate to support rural residential domestic demands; but not other irrigation, industrial or waterworks demands unless storage is provided. A flow of 283 litres/sec (10 cfs) is maintained in the Qualicum River for other demands.

To meet instream flow requirements downstream and to preserve primary fish habitat in natural water bodies, extractions from fish bearing lakes such as Horne, Illusion, Spider, Cameron and Labour Day are not to reduce the shoal area (top 6 m of lake height) by more than 10%.

Fish and debris screens shall be required on all intake or diversion works within the identified fish habitat areas. Fish and debris screens are part of a good intake design and should be encouraged on all intakes or diversion works. Fish passage provisions for both juvenile and adult fish shall be required on all storage dams or diversion works constructed on sources frequented by fish. Appendix G contains information on fish screening requirements.

In stream works are to be constructed only during the period specified by the fisheries agencies to minimize impacts on the fish resources. In stream work will normally only be allowed from July 15 to September 15.

The licenced water demands within the Qualicum River Water Allocation Plan area consist of Domestic, Municipal Waterworks, Industrial, Irrigation, Storage, Land Improvement, and Conservation purpose licences. The largest number of water licences issued are for domestic purposes. However, the actual licenced demand for domestic purposes does not significantly impact other water interests, except where there is a local competing water demand conflict. The largest existing annual licenced water demands are for conservation purposes and storage purposes. The conservation demands enhance fish resources in fish hatcheries.

There is not sufficient storage developed or proposed to maintain and support the existing and projected water demands throughout the low flow period. Further extractive demands, such as municipal waterworks and irrigation, will require supporting storage if the instream fish resources are to be maintained. Also, any further significant salmon enhancement proposals that would increase fish stocks in a stream will require the development of supporting storage to maintain required low flows. When applications for increased licenced water demands are received from existing licencees, storage shall be required for all existing and proposed licenced water demands. The licenced storage and the conflict with land uses on Horne Lake should be resolved. Either the licenced storage on Horne Lake should be reduced or the flooded land around the lake purchased and reserved for flooding.

Table 16 summarizes the water available for the identified significant drainage areas, not accounting for existing licenced water demand.

Table 16: Qualicum River - Water Availability

DRAINAGE	DRAINAGE AREA (Km ²)	WATER VOLUME AVAILABLE	
		HIGH FLOW (dam ³)*	LOW FLOW (litres/sec)**
Little Qualicum River	251.17	168,343	0 (except for domestic demands)
Whisky Creek	26.36	15,546	0
Annie Creek	5.36	3,164	0
Westglade Brook	4.56	2,694	0
Qualicum River	416.28	48,073	283

* High Flow is the quantity of water available above 60% MAD during the period from October through April, except for the Little Qualicum River from October through May.

** Low Flow is the minimum mean monthly quantity of water available above instream requirements during the period from May through September, except for the Little Qualicum River from June through September.

6.1 Domestic

A domestic water licence shall be 2,273 litres/day (500 gpd) for each rural dwelling as indicated on the plan attached to the water licence application. This amount will allow for the maintenance of 0.10 hectares (0.25 acres) of garden associated with the dwelling. It is not appropriate to issue additional water licences for the maintenance of green lawns and gardens when the primary source of a domestic water supply is insufficient.

Domestic water licences shall not be issued to provide evidence of an “adequate potable water supply” for subdivision development. Residential land subdivisions shall be encouraged to connect to existing community water supply systems or to develop a community water supply of their own.

To ensure an adequate domestic water supply for household uses, applicants should be prepared to develop storage or use naturally stored water from lakes or marshes, except for domestic water demands from the mainstem of the Little Qualicum River and the Qualicum River. For the average daily demand of 1,136 litres/day (250 gpd) for a three month period (92 days), a volume of 0.1 dam³ (4,000 ft³ or 0.08 acft) is required. This requires a reservoir or a dugout of approximately 7 metres (23 feet) long by 5 metres (16 feet) wide, with an average depth of 3.5 metres (12 feet); allowing 0.3 metres (1 foot) for evaporation loss.

Dimple springs or springs that are not directly connected by a surface channel to a stream may not require supporting storage if the spring can supply at least 2,273 litres/day (500 gpd) during the months of August and September. The applicant shall provide adequate pump tests and measurements during this period to determine the safe flow yield. Multiple domestic water licences on a spring will only be authorized if the applicant can provide assurances that adequate water is available by determining the safe flow yield near the end of the low flow period (i.e. pump test in August or September) and by satisfying any written concerns and objections of any existing water licencees.

A water licence for domestic use shall not be issued to a residence within a community water supply area unless written leave to do so is obtained from the community water supply agency.

Measuring or regulating (i.e. metering) is not usually required with domestic water usage. An adequate screen shall be installed on the intake to prevent fish and debris from entering the works.

6.2 Waterworks

Waterworks purpose in the Water Act is the carriage or supply of water by a municipality, improvement district, regional district or private utility for the purpose of providing water to a residential area.

The demand for waterworks will greatly increase in the coming years, as the Qualicum River Water Allocation Plan area is further developed.

Applicants for a waterworks demand shall be required to assess the supply for a 10 year projected demand and provide evidence that the projected demand is not excessive in comparison with adjoining community demands. As well, water conservation will be promoted (i.e. residential meters, pricing practices, education) and adequate system balancing storage (i.e. volume difference between maximum hour and maximum day demands) will be constructed or available for peak hour demands. Water Utilities will also have to provide evidence that the appropriate requirements for a Certificate of Public Convenience and Necessity (CPCN) have been met and a CPCN will be obtained. Licenced allocations will be limited to a 10 year projected demand except where the applicant can provide satisfactory evidence that a longer projection period is required (i.e. because the cost of construction of works must be amortised over a longer period).

The licensee shall be required to meter or measure and record the water diverted from the source stream. The licensee shall be required to treat the water supply in accordance with the Ministry of Health requirements. All waterworks licence applications, except for up to a total of 283 litres/sec (10 cfs) on the Qualicum River mainstem, will require storage to support demand.

Adequate system balancing storage shall be required to ensure that the rate of withdrawal from the source during short term or maximum hour demand does not exceed the maximum daily demand. Good conservation techniques must be practised at all times and no increase in the amount of water in existing community waterworks licences must be allowed unless meters and other conservation measures have been used.

Storage and diversion structures must be capable of maintaining or improving existing low flows during the three month low flow period, and maintaining fish passage where required.

6.3 Irrigation

The crop rooting depth, soil type and climatic characteristics determine requirements for irrigation.

The estimated irrigation water requirements for shallow and deep root zone depths for classes of similar soil associations were obtained from the Regional Water Management Policy of Vancouver Island Region (1996). Where composites of two or three soil associations are intermixed or occupy such small areas that they cannot be separated at the scale of the mapping, only the predominant soil association was considered. Figure 20 illustrates the annual irrigation water requirements for various soil groups in the plan area.

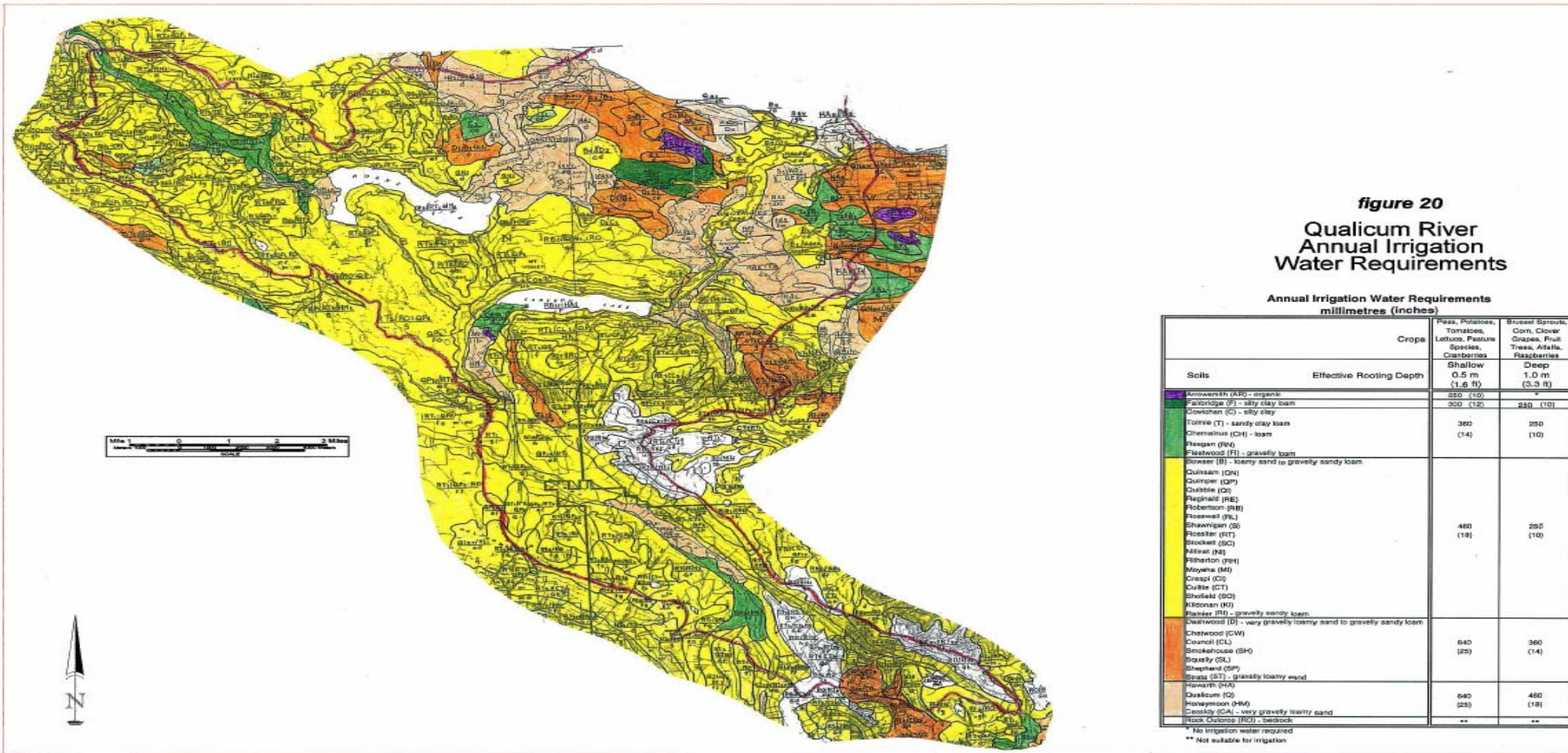

If the applicant for a water licence can provide more specific soil assessment and irrigation requirement information for a given area, that soil assessment and irrigation requirement may be used to assess irrigation demands.

It should be noted that these annual irrigation water requirements are for sprinkler irrigation systems only.

Irrigation gun or flood irrigation systems may require greater quantities of water and should be discouraged. If irrigation gun and flood irrigation practices are to be used, suitable meters shall be installed and water withdrawals limited to the equivalent annual irrigation requirements for sprinkler systems. As the equivalent annual irrigation water requirements for sprinkler systems may not be adequate to sustain crops using these less efficient methods of irrigation, the applicant may be required to reduce crops, limit the acreage irrigated or convert to a more efficient irrigation system. Trickle irrigation can reduce water requirements by 35% and should be encouraged where practical.

All irrigation water demands, except from the Qualicum River mainstem, must be supported by storage development. Storage required to support irrigation demands is the total required amount as per crop and soils, plus an additional allowance for evaporation and other losses from the storage reservoir.

The maximum irrigation flow rate shall not exceed 19.1 litres/sec (4.2 imperial gals. per minute) per 0.4 hectare (1 acre), and users must be encouraged to employ good agricultural practices (field size, system selection and farm management) to conserve water. The authorized period of use for irrigation shall be from April 1 to September 30.

As noted above, all intake works in fish bearing waters shall be screened to prevent fish and debris from entering the intake.

6.4 Industrial and Commercial

Industrial water licences and water licence application demands are typically associated with campgrounds, restaurants, fish culture, golf courses, oyster processing and stock watering. Industrial water demands within the Qualicum River Water Allocation Plan area are associated with campgrounds, restaurants and stock watering.

Commercial fish hatcheries and/or rearing purposes shall require an industrial water licence. Use of water by government and non-profit organizations will be licenced as conservation purpose. Information on fish species and size, water temperature requirements and operating methods will be required to support an application for a water licence. Fish Farm and Waste Management Permits will also be required. Off-stream storage is required for fish ponds associated with commercial fish farming.

Golf course watering is essentially an irrigation water demand except that the watering is not restricted to the irrigation period of April to September. The quantity of water required should be determined as previously stated in the irrigation section. Except for the period of water withdrawal, which shall be the whole year, the same requirements and conditions as irrigation demands shall apply. Storage is required to support these demands.

Cattle or livestock watering requiring more than 450 litres/day (100 Igpd) are to be considered an Industrial (Agricultural) demand. Cattle or livestock requiring 450 litres/day (100 Igpd) or less will be considered a Domestic (livestock) demand. Estimated livestock demands are in the following table.

Table 17: Recommended Livestock Requirements		
Livestock	Water Requirements	
	litres/day	Igpd
cattle (beef) per animal	45	10
cattle (dairy) per animal	132	29
chickens per 100 animals	27	6
turkeys per 100 animals	55	12

Industrial demands related to commercial resort development should be handled similar to multiple domestic demands with the same requirements.

6.5 Storage

Storage purpose is the impoundment of water, either on-stream or off-stream in a dugout or behind a dam. In the unlikely event that a large storage development to support a major demand (eg. hydro power, pulp & paper, large waterworks) is proposed, a more specific supply versus demand and environmental impact assessment will be required.

The storage quantity required to maintain the smaller water demands anticipated to support domestic, industrial, commercial and irrigation uses shall be the volume of the water demand during the low flow period as noted above, plus an additional allowance of 0.3 metres (1.0 foot) depth over the surface area of the storage reservoir for evaporation and other losses.

The water licence applicant shall be required to complete an adequate report for “Dam and Reservoir Information Required in Support of a Water Licence Application for Storage Purpose (Schedule 2)” with the water licence application. If the required report is not provided, the application will be refused.

Total storage (dead and live) will be licenced. Dead storage should be licenced as it will in most cases have some intrinsic value such as providing water for wildlife or aesthetic value.

Diversion of water into off-stream storage will be during the high flow period of October through April/May (7/8 months). Provision to maintain flows during the low flow period from May/June through September shall be required for all instream storage reservoirs.

The applicant shall obtain written agreement, right-of-way or easement for works or flooding affecting other lands.

Fish passage is required for both juvenile and adult fish at all dams in fish bearing streams. Design of storage dams must consider fish ladders and provide adequate flow release and maintain fish passage where required. Instream storage work will normally be allowed between July 15 and September 15. Mitigation work will be required for loss of spawning areas in the creeks affected by any storage.

Design plans must be submitted and accepted in writing before construction commences on any proposed dam over 3 metres (10 feet) in height or on storage of 12 dam³ (10 acft) or more.

All water licencees that develop storage greater than 100 dam³ (80 acft) shall be required to record and report the water level of the reservoir and flows from the reservoir as directed by the “Engineer” as defined in the Water Act of BC.

Off-stream storage dugouts that are outside the high water winter wetted perimeter of any water course, that are not accessible by fish and do not adversely impact on flows in any watercourse during the low flow period, are encouraged.

6.6 Land Improvement

Land improvement purpose is the impoundment of water on a stream or the diversion of water from a stream to facilitate the development of a park, to construct or maintain an aesthetic pond, to protect property from erosion or to drain and reclaim land. No significant water quantity is removed from the stream. Land improvement demands are non-consumptive uses of the water resource.

Water used to facilitate the development of a park is usually maintained in a dammed lake or reservoir for recreation (i.e. boating, fishing, swimming, golf course water traps) and aesthetics. The dammed lake or reservoir is usually filled during the high flow period and the water levels maintained or gradually lowered during the low flow period. Golf courses also acquire water licences to construct and maintain dugouts or control the volume of water in small ponds for water traps and aesthetics. Property owners likewise may acquire a water licence to construct and maintain dugouts and control the volume of small ponds for aesthetics and to increase property values. These water demands are essentially storage developments that do not support an extractive use. Therefore, all the requirements noted for storage development shall be required for land improvement development where applicable. No supporting storage is required. The water quality required to facilitate the development of a park or create an aesthetic pond shall be the volume of the impoundment.

Constructing ditches to drain swamps or marshes, confining or straightening the meandering of stream channels and relocating a stream channel adjacent to a property line is sometimes proposed to accommodate subdivision or building development. Post-development flow conditions should be maintained as near as possible to pre-development flow conditions. The development of land improvement detention dugouts or the control of water in natural ponds, swamps and marshes to reduce flood flow and increase low flow releases will be encouraged. Proposed construction of works on streams that drain swamps or marshes or increase high flow conditions and reduce low flow conditions will not be authorized.

6.7 Conservation

Conservation purpose is the use and storage of water or the construction of works in and about a stream for the enhancement of fish and wildlife for non-profit purposes.

Salmon enhancement proposals that would significantly increase fish stocks in the stream channels will require the development of supporting storage to maintain required low flows. All the requirements noted for storage development shall be required for conservation development where applicable.

6.8 Allocation Plan Revision

The Qualicum River Water Allocation Plan should be reviewed and updated on or before December 2001.

REFERENCES

- Jungen, J. 1975-78. Soils of Southern Vancouver Island. MoE, Surveys and Resource Mapping Branch, Victoria.
- MoE. 1987. Horne Lake Reservoir. Storage and Basin Data Package. MoE, Water Management Branch, Surveys Section.
- Norris, J.G. 1986. Reconnaissance Survey of Spider Lake. Ed. Grant, D.J. MoE, Recreational Fisheries Branch, Nanaimo/Cowichan.
- Norris, J.G. 1986. Reconnaissance Survey of Illusion Lakes. Ed: Coombs, D.M.V. MoE, Recreational Fisheries Branch, Nanaimo/Cowichan.
- Regional District of Nanaimo. 1989. Shawhill - Deep Bay Technical Report. Planning Department, Nanaimo

APPENDIX A: Canadian Climatic Normals

Atmospheric Environment Science (AES) Stations
Qualicum River Fish Research Station
&
Cameron Lake Station

Qualicum River Fish Research Stn.

1962 - 1990

Temperature	Jan	Feb	Mar	Apr	May	Jun	Jul	Aug	Sep	Oct	Nov	Dec	Year
Daily Maximum (°C)	5.4	7.3	9.5	12.4	16.1	19.2	21.7	21.6	18.1	13.0	8.3	5.8	13.2
Daily Minimum (°C)	0.0	0.8	1.4	3.5	6.8	9.9	11.4	11.3	8.5	5.3	2.4	0.6	5.2
Daily Mean (°C)	2.7	4.1	5.5	8.0	11.5	14.6	16.6	16.5	13.3	9.1	5.4	3.2	9.2
Extreme Maximum (°C)	14.4	16.1	18.9	23.3	31.5	30.0	31.1	31.1	32.0	22.0	17.8	16.0	
Date	68/20	77/19	64/30	71/25	83/29	89/03	65/31	77/04	87/01	87/01	75/04	80/10	
Extreme Minimum (°C)	-15.6	-13.0	-9.0	-2.8	0.0	2.8	5.0	4.4	-0.5	-6.0	-14.0	-14.4	
Date	69/30	89/04	89/03	75/02	75/24	73/01	72/01	74/26	83/28	84/31	85/29	68/28	

Degree-Days	Jan	Feb	Mar	Apr	May	Jun	Jul	Aug	Sep	Oct	Nov	Dec	Year
Above 18 °C	0.0	0.0	0.0	0.0	0.2	2.6	9.9	9.5	0.6	0.0	0.0	0.0	23.0
Below 18 °C	475.7	396.4	388.5	300.6	203.4	106.3	52.9	57.4	141.5	274.4	378.5	456.1	3232.0
Above 5 °C	10.9	16.2	33.3	91.3	199.8	286.3	360.0	355.0	249.2	130.0	40.9	17.6	1791.0
Below 0 °C	12.1	3.8	0.5	0.0	0.0	0.0	0.0	0.0	0.0	0.1	3.0	8.9	28.0

Precipitation	Jan	Feb	Mar	Apr	May	Jun	Jul	Aug	Sep	Oct	Nov	Dec	Year
Rainfall (mm)	163.3	135.5	113.4	65.9	48.6	39.9	29.4	31.6	56.9	145.2	210.5	198.0	1238.2
Snowfall (cm)	19.8	11.5	1.2	0.3	0.0	0.0	0.0	0.0	0.0	0.2	3.4	13.4	49.7
Precipitation (mm)	183.8	147.0	114.6	66.2	48.6	39.9	29.4	31.6	56.9	145.4	213.9	215.2	1292.6
Extreme Daily Rainfall (mm)	117.3	77.4	69.1	29.5	27.7	34.2	25.4	38.1	41.6	80.4	85.1	85.4	
Date	73/14	83/10	74/09	70/05	73/23	80/25	74/16	75/22	83/17	81/30	66/27	80/26	
Extreme Daily Snowfall (cm)	49.0	45.7	12.7	4.6	0.0	0.0	0.0	0.0	0.0	6.4	11.7	45.7	
Date	78/03	75/11	71/01	72/11	90/31	90/30	90/31	90/31	90/30	84/31	74/20	68/30	
Extreme Daily Pcpn. (mm)	117.3	77.4	69.1	29.5	27.7	34.2	25.4	38.1	41.6	80.4	85.1	85.4	
Date	73/14	83/10	74/09	70/05	73/23	80/25	74/16	75/22	83/17	81/30	66/27	80/26	
Month-end Snow Cover (cm)	N	0.0	0.0	0.0	0.0	0.0	0.0	0.0	0.0	0.0	0.0	1.0	

Days With	Jan	Feb	Mar	Apr	May	Jun	Jul	Aug	Sep	Oct	Nov	Dec	Year
Maximum Temperature > 0°C	30	28	31	30	31	30	31	31	30	31	30	30	362
Measurable Rainfall	16	15	16	13	11	9	7	7	9	15	19	17	155
Measurable Snowfall	4	1	*	*	0	0	0	0	0	*	*	3	9
Measurable Precipitation	18	16	16	14	11	9	7	7	9	15	19	19	160

Cameron Lake Stn.

1924 - 1986

Precipitation	Jan	Feb	Mar	Apr	May	Jun	Jul	Aug	Sep	Oct	Nov	Dec	Year
Rainfall (mm)	194.6	192.9	134.7	85.5	61.0	45.0	32.4	41.9	70.9	198.1	243.1	237.1	1537.2
Snowfall (mm)	39.7	14.4	7.9	2.5	0.0T	0.0	0.0	0.0	0.0	0.0T	7.5	29.2	101.3
Precipitation (mm)	231.6	206.7	142.1	88.1	61.0	45.0	32.4	41.9	70.9	198.1	250.6	266.1	1634.6
Extreme Daily Rainfall (mm)	108.0	96.8	103.0	76.2	71.1	38.1	40.1	61.0	83.8	93.2	94.0	121.7	
Date	33/09	83/10	83/08	50/11	48/28	47/02	45/21	75/22	48/15	81/30	39/14	26/31	
Extreme Daily Snowfall (mm)	43.2	49.8	25.4	11.4	0.0	0.0	0.0	0.0	0.0	7.6	25.4	38.1	
Date	51/15	75/11	51/07	72/12	86/31	86/30	86/31	86/31	85/30	30/16	46/20	37/25	
Extreme Daily Pcpn. (mm)	108.0	96.8	103.0	76.2	71.1	38.1	40.1	61.0	83.8	93.2	97.8	121.7	
Date	33/09	83/10	83/08	50/11	48/28	47/02	45/21	75/22	48/15	81/30	48/27	26/31	
Month-end Snow Cover (cm)	N	N	0.0	0.0	0.0	0.0	0.0	0.0	0.0	0.0	1.0	N	

Days With	Jan	Feb	Mar	Apr	May	Jun	Jul	Aug	Sep	Oct	Nov	Dec	Year
Measurable Rainfall	13.0	14.0	14.0	12.0	10.0	8.0	6.0	6.0	9.0	14.0	17.0	14.0	139.0
Measurable Snowfall	4.0	2.0	2.0	*	0.0	0.0	0.0	0.0	0.0	0.0	1.0	4.0	14.0
Measurable Precipitation	16.0	15.0	15.0	12.0	10.0	8.0	6.0	6.0	9.0	14.0	18.0	17.0	147.0

APPENDIX B: Water Survey of Canada (WSC) Hydrometric Information

Monthly and Annual Mean Discharges
and
7-Day Low Flows

08HB001	Qualicum River near Bowser
08HB004	Little Qualicum River at outlet of Cameron Lake
08HB018	Qualicum River at outlet of Horne Lake
08HB019	Cameron River Near Alberni
08HB021	Horne Lake near Bowser
08HB029	Little Qualicum River near Qualicum Beach

QUALICUM RIVER NEAR BOWSER 08HB001

YEAR	JAN	FEB	MAR	APR	MAY	JUN	JULY	AUG	SEPT	OCT	NOV	DEC	MAD
1913	M	M	4.29	6.13	5.39	6.77	4.46	2.13	3.37	10.2	12	14.7	M
1914	38.8	20.2	29.5	24.2	M	3.23	1.79	1.03	1.68	20.7	25.2	6.88	M
1915	9	7.29	7.61	8.54	3.03	1.7	0.845	0.598	0.566	7.03	11	15.7	6.07
1916	4.59	15.8	21.6	12.3	8.93	6.84	4.05	1.58	0.972	0.635	5.63	7.35	7.49
1917	7.52	7.68	4.26	10.7	10.9	6.63	2.41	0.863	0.924	1.94	5.9	15.9	6.3
1918	25.9	42.2	27.5	11.9	4.98	3.56	1.12	1.41	0.896	1.7	7.08	12.2	11.5
1919	15.9	13.4	9.67	12.4	8.11	6.04	3.63	1.27	0.708	0.644	8.67	12.6	7.72
1920	8.9	7.7	5	2.99	2.28	3.16	1.32	1	7.96	12.7	9.93	16.7	6.64
1921	13.7	10.6	5.87	3.47	4.14	4.14	1.99	1.15	3.77	15.3	11.7	14.9	7.55
1922	4.39	5.65	4.18	5.78	7.27	4.79	1.45	0.793	1.57	M	M	M	M
1956	M	M	M	M	M	M	3.14	1.2	1.12	8.37	8.61	12.9	M
1957	M	M	M	8.76	5.09	2.12	M	M	M	2.39	4.48	18.2	M
1958	42.7	21.4	14.8	M	M	2.06	1.02	0.701	0.977	6.11	8.57	53.1	M
1959	23.9	4.53	7.84	6.69	6.44	3.27	1.67	1.08	1.16	2	7.84	16.7	6.97
1960	7.31	15.9	6.22	12.4	6.97	4.35	1.72	0.811	0.948	3.92	12.1	13.5	7.12
1961	29.5	24.6	13.4	6.24	5.88	3.31	1.24	0.553	0.697	3.32	7.44	10.3	8.79
1962	14.3	5.74	4.35	5.59	5.55	2.89	1.33	5.89	4.61	4.54	7.64	17.7	6.7
1963	9.05	19	7.09	7.22	4.18	1.5	1.17	0.889	0.749	12.6	20.3	16.8	8.3
1964	M	M	M	M	M	4.91	4.01	1.38	1.31	6.64	7.6	6.62	M
1965	4.84	8.36	7.51	5.02	4.89	2.34	2.1	1.85	3.72	6.29	6.92	10.7	5.36
1966	18.5	15.5	6.88	6.82	6.02	3.5	3.06	2.75	2.7	8.7	7.44	15.1	8.05
1967	19.7	14.5	7.41	7.21	6.74	3.54	3.51	2.97	2.47	7.07	10.8	8.12	7.8
1968	15.3	16.8	6.63	5.12	4.21	2.75	2.46	6.7	10.8	11	8.49	8.7	8.21
1969	8.94	8.86	5.26	5.58	5.67	6.42	4	4.8	19.4	10.7	8.13	7.58	7.91
1970	6.16	5.44	5.4	5.24	4.4	2.45	1.66	1.99	5.34	6.12	5.84	4.79	4.56
1971	5.16	11.5	8.29	6.48	5.83	4.75	3.34	2.12	7.33	8.93	13.9	8.04	7.1
1972	7.09	7.53	10	8.46	6.43	4.3	1.79	1.63	4.6	4.66	4.18	5.06	5.47
1973	14.8	8.22	5.93	4.99	4.65	2.25	1.68	1.71	2.72	6.9	8.97	17.4	6.69
1974	12.4	13.7	12.4	11.1	7.9	3.75	3.31	3.62	11.3	6.35	6.29	9.03	8.39
MEAN	14.73	13.28	9.57	8.13	5.84	3.83	2.33	1.95	3.73	7.05	9.38	13.47	7.30
% of MAD	202%	182%	131%	111%	79.9%	52.5%	31.9%	26.6%	51.0%	96.6%	128%	184%	100%

M = MISSING DATA

QUALICUM RIVER NEAR BOWSER (08HB001)				
7-Day Average Low Flow (m³/sec)				
Year	Date	Apr 1-Sep 30	Date	Jan 1-Dec 31
1913	15-Aug-13	1.98	15-Aug-13	1.98
1914	8-Aug-14	0.991	8-Aug-14	0.991
1915	11-Aug-15	0.566	11-Aug-15	0.566
1916	27-Sep-16	0.91	10-Oct-16	0.566
1917	19-Aug-17	0.708	19-Aug-17	0.708
1918	20-Sep-18	0.708	20-Sep-18	0.708
1919	26-Aug-19	0.708	24-Oct-19	0.425
1920	19-Aug-20	0.765	19-Aug-20	0.765
1921	13-Aug-21	0.991	13-Aug-21	0.991
1922	31-Jul-22	0.793	31-Jul-22	0.793
1956	7-Sep-56	0.985	7-Sep-56	0.985
1958	23-Aug-58	0.627	23-Aug-58	0.627
1959	22-Aug-59	1.02	22-Aug-59	1.02
1960	16-Aug-60	0.711	16-Aug-60	0.711
1961	27-Aug-61	0.398	27-Aug-61	0.398
1962	1-Aug-62	0.951	1-Aug-62	0.951
1963	5-Sep-63	0.706	5-Sep-63	0.706
1964	6-Sep-64	0.917	6-Sep-64	0.917
1965	30-Aug-65	1.74	30-Aug-65	1.74
1966	25-Aug-66	2.7	25-Aug-66	2.7
1967	22-Sep-67	2.44	5-Dec-67	1.53
1968	13-Jun-68	2.46	13-Jun-68	2.46
1969	7-Aug-69	3.75	7-Aug-69	3.75
1970	4-Jul-70	1.53	4-Jul-70	1.53
1971	23-Aug-71	1.89	23-Aug-71	1.89
1972	13-Aug-72	1.59	13-Aug-72	1.59
1973	17-Jun-73	1.68	17-Jun-73	1.68
1974	11-Jul-74	3.12	11-Jul-74	3.12
MEAN =		1.4	MEAN =	1.3

LITTLE QUALICUM RIVER AT OUTLET OF CAMERON LAKE (08HB004)

YEAR	JAN	FEB	MAR	APR	MAY	JUN	JULY	AUG	SEPT	OCT	NOV	DEC	MAD
1913	M	M	4.86	7.56	10.3	11	7.34	2.15	3.29	7.43	15.4	12.1	M
1914	17.9	6.86	14.1	14	10.8	7.87	3.79	1.53	2.58	18.6	23.3	7.34	10.7
1915	7.72	6.95	9.74	13.2	6.19	3.52	1.61	1.06	0.89	8.21	9.46	13.7	6.86
1916	4.68	10.6	14.2	10.5	12.4	14.4	9.48	3.78	1.66	1.33	5.7	4.97	7.78
1917	5.72	6.54	3.41	5.79	11.1	12	5.97	2.1	1.84	4.3	8.32	17	7.01
1918	21	19	12.2	9.57	6.76	4.82	2.01	1.97	1.17	2.87	10.2	13.1	8.66
1919	12.5	12.2	6.71	12.7	12.3	9.8	6.91	2.81	1.56	1.2	11.4	14.7	8.7
1920	9.31	7.82	4.68	3.05	3.81	5.57	2.26	1.46	9.37	13.3	10.8	13.1	7.05
1921	10.7	9.03	6.71	5.06	9.26	11.8	5.15	2.03	5.46	19.6	12.5	17.7	9.6
1922	4.22	3.94	2.42	3.43	11.1	11	3.25	1.6	2.74	M	M	M	M
1960	M	M	M	M	M	M	M	M	M	5.1	9.85	14.4	M
1961	30.9	22.2	13.2	9.25	11.7	6.07	2.34	0.986	2.06	6.54	7.63	12.2	10.4
1962	15.7	7.84	2.91	8.05	6.9	5.29	1.99	3.01	1.48	9.51	16.7	22.3	8.48
1963	11.6	22.7	8.72	8.55	7.64	2.94	2.15	1.29	0.923	11.6	19.1	23.9	10
1964	17.3	10.8	6.64	6.59	8.06	9.93	5.77	2.2	1.96	M	6.18	10.5	M
1965	5.72	11.2	5.45	5.93	7.27	3.94	1.51	0.968	0.768	11.1	15.4	17.7	7.22
1966	16.4	8.88	7.27	10.2	8.82	8.05	4.96	1.48	1.47	5.39	13.2	36	10.2
1967	16.2	11.2	10.7	4.61	9.13	9.16	2.67	1.01	0.739	18.6	11.8	20.5	9.72
1968	34.5	18.1	12.8	5.73	8.72	5.81	3.23	1.58	2.14	14.8	16	15.3	11.6
1969	5.63	5.84	7.21	13.2	19.4	13.6	3.18	1.44	4.97	5.57	10.4	12.4	8.56
1970	8.78	9.84	7.46	8.47	6.28	4.33	1.11	0.904	1.2	3.64	8.97	9.73	5.86
1971	13.7	16.7	7.84	8.43	15.9	11.4	6.8	2.78	2.69	5.11	15	6.24	9.32
1972	7.08	10.7	21.1	9.87	10.3	8.44	7.31	1.83	2.48	1.76	8.43	18.8	9.02
1973	20.1	10.5	8.07	4.79	10.6	7.64	2.85	1.13	0.854	4.83	11.6	24.7	9
1974	23.8	11.3	17.3	12.1	12.3	13.8	8.47	2.92	1.61	1.69	14	17.8	11.4
1975	8.82	5.05	7.98	5.41	11.9	9.4	3.45	2.61	3.36	17.6	41	18.5	11.3
1976	14.5	10.2	7.08	8.16	12.3	8.71	6.62	3.03	2.68	2.35	7.87	14.2	8.15
1977	7.68	12.1	8.77	9.96	6.87	4.25	1.53	0.936	1.51	7.65	18.1	17.1	8
1978	11.1	10.6	9.91	7.22	5.56	3.88	1.49	1.63	6.18	4.15	6.5	5.54	6.11
1979	2.86	12	15.3	6.06	8.98	3.8	2.78	1.26	4.8	7.44	4.51	27	8.07
1980	11.5	14.3	9.75	11.5	6.67	4.33	3.67	1.16	1.28	2.48	18.3	27.6	9.35
1981	12.1	17	5.38	9.63	6.8	4.37	2.16	0.9	2.37	11.5	25.6	18.4	9.62
1982	8.53	19.4	8.13	5.32	10.8	11.4	3.57	1.1	1.43	14.8	9.07	19	9.33
1983	20.9	28.8	17.6	6.73	7.25	6.74	5.34	1.5	1.74	2.76	26.3	7.23	10.9

LITTLE QUALICUM RIVER AT OUTLET OF CAMERON LAKE (08HB004)

YEAR	JAN	FEB	MAR	APR	MAY	JUN	JULY	AUG	SEPT	OCT	NOV	DEC	MAD
1984	16.3	13.5	10.8	8.21	10.5	7.19	3.25	1.35	2.24	15.1	17.4	10.8	9.71
1985	4.21	4.01	3.3	9.92	8.54	4.2	1.14	0.752	0.981	7.62	5.85	4.33	4.57
1986	21.9	14.5	16.8	7.74	11.2	4.66	1.98	0.853	0.841	1.21	10.7	17	9.11
1987	19.7	16.6	15.9	8.28	7.78	7.39	2.11	0.806	0.42	1.06	5.46	14.4	8.3
1988	7.87	8.44	8.05	12.6	11.9	8.66	2.69	1.24	1.08	2.08	16.7	9.65	7.55
1989	9.83	6.55	6.47	12.8	7.91	4.42	1.43	1.11	0.584	5.01	8.77	11	6.31
1990	11	10.1	7.07	9.44	5.18	7.37	1.79	0.865	0.649	7.97	30.4	19	9.19
1991	10.9	25.9	4.73	7.41	4.99	2.41	1.01	4.67	4.82	1.51	14.2	15	8
1992	29	21.1	6.13	5.34	4.2	1.17	0.754	0.666	0.902	6.28	9.4	5.98	7.54
1993	5.61	7.24	12.1	9.86	9.75	5.11	1.56	1.1	M	M	M	M	M
MEAN	13.23	12.34	9.23	8.42	9.21	7.25	3.50	1.66	2.23	7.33	13.51	15.19	8.67
% of MAD	152%	142%	106%	97.1%	106%	83.6%	40.3%	19.2%	25.7%	84.5%	156%	175%	100%

M = MISSING DATA

LITTLE QUALICUM RIVER AT OUTLET OF CAMERON LAKE (08HB004)				
7-Day Average Low Flow (m³/sec)				
Year	Date	Apr 1-Sep 30	Date	Jan 1-Dec 31
1913	27-Aug-13	1.61	27-Aug-13	1.61
1914	6-Sep-14	1.11	6-Sep-14	1.11
1915	27-Sep-15	0.825	27-Sep-15	0.825
1916	27-Sep-16	1.31	25-Oct-16	1
1917	3-Sep-17	1.44	3-Sep-17	1.44
1918	27-Sep-18	0.979	1-Oct-18	0.89
1919	27-Sep-19	1.36	29-Oct-19	1.12
1920	23-Aug-20	1.13	23-Aug-20	1.13
1921	16-Sep-21	1.75	16-Sep-21	1.75
1922	29-Aug-22	1.36	29-Aug-22	1.36
1961	27-Aug-61	0.796	27-Aug-61	0.796
1962	24-Sep-62	1.11	24-Sep-62	1.11
1963	12-Sep-63	0.838	5-Oct-63	0.809
1964	10-Sep-64	1.26	10-Sep-64	1.26
1965	27-Sep-65	0.694	30-Sep-65	0.686
1966	6-Sep-66	0.946	6-Sep-66	0.946
1967	27-Sep-67	0.653	27-Sep-67	0.653
1968	15-Aug-68	1.25	15-Aug-68	1.25
1969	12-Sep-69	1.08	12-Sep-69	1.08
1970	1-Sep-70	0.561	1-Sep-70	0.561
1971	1-Sep-71	1.94	1-Sep-71	1.94
1972	16-Sep-72	0.878	16-Sep-72	0.878
1973	14-Sep-73	0.739	14-Sep-73	0.739
1974	27-Sep-74	1.17	27-Sep-74	1.17
1975	17-Aug-75	1.35	17-Aug-75	1.35
1976	27-Sep-76	2	20-Oct-76	1.43
1977	20-Aug-77	0.783	20-Aug-77	0.783
1978	8-Aug-78	0.862	8-Aug-78	0.862
1979	13-Aug-79	1.11	13-Aug-79	1.11
1980	25-Aug-80	0.562	25-Aug-80	0.562
1981	15-Sep-81	0.694	15-Sep-81	0.694
1982	27-Aug-82	0.56	27-Aug-82	0.56
1983	26-Aug-83	1.01	26-Aug-83	1.01
1984	30-Aug-84	0.885	30-Aug-84	0.885
1985	1-Sep-85	0.591	1-Sep-85	0.591
1986	10-Sep-86	0.528	10-Sep-86	0.528
1987	27-Sep-87	0.369	28-Sep-87	0.353
1988	19-Sep-88	0.542	19-Sep-88	0.542
1989	27-Sep-89	0.456	28-Sep-89	0.448
1990	27-Sep-90	0.481	29-Sep-90	0.434
1991	12-Jul-91	0.715	12-Jul-91	0.715
1992	29-May-92	0.396	29-May-92	0.396
MEAN =		0.97	MEAN = 0.94	

QUALICUM RIVER AT OUTLET OF HORNE LAKE

(08HB018)

YEAR	JAN	FEB	MAR	APR	MAY	JUN	JULY	AUG	SEPT	OCT	NOV	DEC	MAD
1958	M	M	M	M	M	1.59	0.365	0.056	0.473	4.7	6.72	21.2	M
1959	15.1	4.12	6.68	6.97	6.08	2.96	1.19	0.284	0.304	1.3	5.85	12.1	5.27
1960	5.58	13.9	5.42	11.1	6	3.84	1.24	0.297	0.371	2.96	9.33	M	M
1961	22.5	19.8	11.6	5.35	6.86	2.68	0.679	0.152	0.25	2.68	5.79	8.13	7.15
1962	11.2	4.57	2.95	4.86	4.84	2.14	0.785	M	M	M	M	M	M
MEAN	13.60	10.60	6.66	7.07	5.95	2.64	0.85	0.20	0.35	2.91	6.92	13.81	6.21
% of MAD	219%	171%	107%	114%	95.7%	42.5%	13.7%	3.2%	5.6%	46.9%	111%	222%	100%

M = MISSING DATA

QUALICUM RIVER AT OUTLET OF HORNE LAKE (08HB018)			
7-Day Average Low Flow (m ³ /sec)			
Year	Date	Apr 1-Sep 30	Jan 1-Dec 31
1958	27-Aug-58	0.031	0.031
1959	27-Aug-59	0.187	0.187
1960	20-Aug-60	0.215	0.215
1961	27-Aug-61	0.072	0.072
MEAN =		0.126	0.126

CAMERON RIVER NEAR ALBERNI

(08HB019)

YEAR	JAN	FEB	MAR	APR	MAY	JUN	JULY	AUG	SEPT	OCT	NOV	DEC	MAD
1958	M	M	M	M	M	M	M	0.552	1.51	M	M	M	M
1959	M	2.81	4.21	M	M	M	M	1.03	1.73	M	M	M	M
MEAN	M	2.81	4.21	M	M	M	M	0.79	1.62	M	M	M	M

M = MISSING DATA

CAMERON RIVER NEAR ALBERNI (08HB019)

7-Day Average Low Flow (m³/sec)

Date	Apr 1-Sep 30
25-Aug-58	0.431
27-Aug-59	0.847
MEAN =	0.639

HORNE LAKE NEAR BOWSER

(08HB021)

YEAR	JAN	FEB	MAR	APR	MAY	JUN	JULY	AUG	SEPT	OCT	NOV	DEC	MAD
1958	M	M	M	M	M	M	M	M	M	0.726	0.877	1.362	M
1959	1.198	0.721	0.876	0.874	M	0.644	0.492	0.341	M	0.488	0.8	1.075	M
1960	0.751	1.168	0.79	M	0.838	M	0.482	0.339	0.358	0.581	M	M	M
1961	M	M	1.094	M	0.905	0.657	0.443	0.329	M	0.664	0.915	1.159	M
1962	1.073	0.788	0.682	0.805	0.794	0.618	0.46	M	M	M	M	M	M
MEAN	1.01	0.89	0.86	0.84	0.85	0.64	0.47	0.34	0.36	0.61	0.86	1.20	M

M = MISSING DATA

HORNE LAKE NEAR BOWSER (08HB021)		
Minimum Daily Water Level (m)		
Date	Apr 1-Sep 30	Jan 1-Dec 30
27-Aug-58	0.213	27-Aug-58 0.213
25-Aug-59	0.308	25-Aug-59 0.308
19-Aug-60	0.311	19-Aug-60 0.311
27-Aug-61	0.283	27-Aug-61 0.283
Mean=	0.279	Mean= 0.279

LITTLE QUALICUM RIVER NEAR QUALICUM BEACH

(08HB029)

YEAR	JAN	FEB	MAR	APR	MAY	JUN	JULY	AUG	SEPT	OCT	NOV	DEC	MAD
1960	M	M	M	M	M	M	M	M	M	M	M	M	M
1961	M	33.9	21.2	13.4	14	7.59	3.29	1.61	3.08	6.72	13.5	22.4	M
1962	21.9	10	5.33	10.2	8.73	6.26	2.55	3.23	2.07	11.7	22.9	31.8	M
1963	16.1	28.5	12.6	12.3	9.63	4.35	3.08	2	1.45	M	M	29.9	M
1964	25.7	13.7	10.7	8.92	10.4	13.7	6.91	3.25	3.06	7.18	9.17	13.2	10.5
1965	10.2	19.1	8.73	10.5	9.13	5.1	2.07	1.37	1.05	14.4	21.1	24.8	10.6
1966	26.9	14.4	13.7	14.7	11.3	9.35	5.2	1.41	1.57	7.08	19.8	41.5	13.9
1967	26.9	18	16.4	7.53	12.7	11.1	3.39	1.48	1.36	22.6	15.4	24.5	13.5
1968	43.1	22.2	16.4	9.43	10.9	6.75	4	2.34	3.07	17.7	22.4	21.3	15
1969	7.64	10.8	12.4	18.1	22.7	14.7	4.22	2.09	7.84	8.47	17.5	17.7	12
1970	11.7	12	9.93	11.1	8.05	5.73	2.27	1.38	1.75	4.9	12.1	15.2	7.98
1971	19.4	20.8	13.3	11.6	17.8	12.3	7.58	3.34	3.51	6.49	18.4	7.71	11.8
1972	10.4	16.9	30	13.7	13.2	10	6.54	2.38	2.89	2.44	10	25.9	12
1973	30.9	12.2	11	6.59	10.8	8.06	3.68	1.45	1.34	7.55	14.3	33.9	11.9
1974	29.7	17.7	25.6	15.8	14.5	15.7	10.4	3.64	1.7	1.87	19.8	23.2	15
1975	12.1	6.48	11.5	8.05	13.7	9.93	4.24	3.51	3.86	21.9	51.3	27	14.5
1976	20.4	14	10.5	11.8	16.2	10.8	7.22	3.51	2.8	2.11	6.84	12.4	9.88
1977	10.5	17.7	12.3	12.4	7.96	5.02	1.71	1.13	1.78	8.41	22	22	10.2
1978	16.5	15.5	13.7	10.7	7.31	5.05	2.02	2.25	7.16	4.37	8.75	8.26	8.42
1979	4.47	17	18.5	8.43	10.5	4.62	3.12	1.25	6.25	10	8.44	36.2	10.7
1980	16	20.5	12.9	14.3	8.36	6.18	4.76	1.7	1.91	3.19	23.3	35.6	12.4
1981	16.5	22	8	12.4	8.98	5.51	3.15	1.63	3.89	13.7	34.1	25.9	12.9
1982	12.8	24.6	11.1	7.75	13.2	12.9	4.55	1.51	1.76	18	11.9	23.5	11.9
1983	25.6	38.7	21.4	8.77	8.65	7.68	5.81	1.99	2.05	3.16	40.5	10.7	14.4
1984	22.3	18.7	14.7	10.4	13.5	9.28	4.68	1.76	4.78	19.7	20.5	12.7	12.7
1985	6.97	6.32	5.31	13	10.3	5.14	1.56	1.03	2.6	10.4	7.14	5.6	6.26
1986	30.4	21.6	24.7	9.81	11	5.19	2.72	1.16	1.16	1.75	14.1	27.1	12.5
MEAN	19.00	18.20	14.30	11.22	11.67	8.38	4.26	2.05	2.91	9.43	18.35	22.21	11.76
% of MAD	162%	155%	122%	95.4%	99.2%	71.3%	36.2%	17.5%	24.8%	80.2%	156%	189%	100%

M = MISSING DATA

LITTLE QUALICUM RIVER NEAR QUALICUM BEACH (08HB029)				
7-Day Average Low Flow (m ³ /sec)				
Year	Date	Apr 1-Sep 30	Date	Jan 1-Dec 31
1961	27-Aug-61	1.29	27-Aug-61	1.29
1962	23-Sep-62	1.61	23-Sep-62	1.61
1963	12-Sep-63	1.42	12-Sep-63	1.42
1964	12-Sep-64	1.95	12-Sep-64	1.95
1965	27-Sep-65	0.911	30-Sep-65	0.889
1966	6-Sep-66	0.785	6-Sep-66	0.785
1967	27-Sep-67	1.2	27-Sep-67	1.2
1968	15-Aug-68	1.8	15-Aug-68	1.8
1969	12-Sep-69	1.78	12-Sep-69	1.78
1970	1-Sep-70	0.934	1-Sep-70	0.934
1971	1-Sep-71	2.8	1-Sep-71	2.8
1972	15-Sep-72	1.45	15-Sep-72	1.45
1973	15-Sep-73	0.97	15-Sep-73	0.97
1974	27-Sep-74	1.15	27-Sep-74	1.15
1975	14-Aug-75	1.7	14-Aug-75	1.7
1976	27-Sep-76	1.78	20-Oct-76	0.989
1977	19-Aug-77	0.994	19-Aug-77	0.994
1978	8-Aug-78	1.34	8-Aug-78	1.34
1979	13-Aug-79	1.07	13-Aug-79	1.07
1980	25-Aug-80	0.946	25-Aug-80	0.946
1981	16-Aug-81	1.32	16-Aug-81	1.32
1982	24-Jul-82	1.11	24-Jul-82	1.11
1983	25-Aug-83	1.45	16-Oct-83	1.28
1984	26-Aug-84	1.14	26-Aug-84	1.14
1985	25-Aug-85	0.921	25-Aug-85	0.921
1986	10-Sep-86	0.786	10-Sep-86	0.786
MEAN =		1.33	MEAN = 1.29	

APPENDIX C: Miscellaneous Flow Records

Cameron River
Whisky Creek
Kinkade Creek
Annie Creek
Olympic Spring
Qualicum River (Monitored & Regulated)

Miscellaneous Flow Records

Stream	Date	Flow	Units
Cameron River	18/10/59	78	cfs
	02/05/60	419	cfs
	05/03/60	373	cfs
	16/6/60	409	cfs
	10/04/60	22.7	cfs
	13/2/61	317	cfs
	17/4/61	213	cfs
	23/6/61	131	cfs
	14/8/61	26.1	cfs
	01/03/62	275	cfs
	28/6/62	82	cfs
	26/10/62	237	cfs
	24/4/63	191	cfs
	09/11/63	8	cfs
	Whiskey Creek	22/5/80	36
09/05/85		29	l/sec
09/11/85		24	l/sec
21/7/93		22.4	l/sec
26/7/93		21.8	l/sec
17/8/93		17.6	l/sec
23/8/93		17.4	l/sec
09/01/93		15.7	l/sec
09/10/93		14.6	l/sec
27/9/93		14.6	l/sec
13/10/93		14	l/sec
Kinkade Creek		09/10/85	94
	09/12/85	96	l/sec
	Jul-92	115	l/sec
	Aug-92	117	l/sec
	Sep-92	105	l/sec
Annie Creek	29/8/85	1.5	l/sec
	09/11/85	2	l/sec
	09/12/85	2	l/sec
	Jul-92	1.5	l/sec
	Aug-92	1.5	l/sec
	Sep-92	1.4	l/sec
Olympic Spring	17/8/83	4.8	l/sec
	22/8/83	3.6	l/sec
	09/02/83	3.6	l/sec
	09/09/83	3.6	l/sec
	23/9/83	3.9	l/sec
	30/9/83	3.6	l/sec
	14/10/83	3.1	l/sec

Monitored and Regulated Water Supplies
QUALICUM RIVER FLOW (cfs)

YEAR	JAN	FEB	MAR	APR	MAY	JUN	JULY	AUG	SEPT	OCT	NOV	DEC	MAD
1985	M	M	M	M	129.64	63.00	40.79	45.00	51.85	109.85	180.36	165.73	M
1986	185.14	204.83	261.07	256.63	162.31	96.08	47.64	49.75	69.38	92.14	147.50	279.64	154.34
1987	536.33	441.80	289.77	194.92	136.15	96.58	86.56	45.38	51.92	113.15	131.77	198.85	193.60
1988	164.83	190.00	178.46	256.45	194.69	139.08	96.25	52.00	58.08	101.25	298.00	294.83	168.66
1989	211.54	159.00	148.62	155.00	167.57	86.83	41.67	69.54	50.00	63.17	136.54	275.50	130.42
1990	216.15	318.77	156.62	144.83	139.31	117.31	76.93	50.00	50.00	105.21	436.00	576.00	198.93
1991	262.75	495.38	203.45	150.00	116.67	55.00	54.17	40.38	63.30	119.73	220.55	318.50	174.99
1992	597.35	667.37	176.43	140.18	87.85	50.23	51.15	62.69	49.15	121.17	201.50	203.91	200.75
1993	174.58	169.55	154.43	157.67	144.91	98.55	65.00	82.30	72.08	109.46	154.62	236.08	134.94
1994	280.46	311.57	407.25	191.60	182.36	80.77	60.00	75.29	65.00	97.69	182.86	345.71	190.05
1995	430.38	419.23	298.93	204.09	173.43	73.85	60.00	76.46	60.00	134.17	373.21	635.00	244.90
1996	422.14	272.08	211.54	165.30	n/a	n/a	n/a	n/a	n/a	n/a	n/a	n/a	n/a
MEAN	316.51	331.78	226.05	183.33	148.63	87.03	61.83	58.98	58.25	106.09	223.90	320.89	179.16
MEAN (excl. 1996)	305.95	337.75	227.50	185.14	148.63	87.03	61.83	58.98	58.25	106.09	223.90	320.89	179.16

M = Data is missing

n/a = Data is not available

APPENDIX D: Licenced Water Demand by Purpose

(June 1996)

LICENCE NUMBER	FILE NUMBER	SOURCE	NUMBER OF LICENCES	QUANTITY/ UNITS	LITRES/SEC.	DEMAND (dam ³ /year)
Conservation Purpose						
C052485	0342743	Cameron Lake		2,400 acft	380.71	
C052484	0342742	Little Qualicum River		32,579 acft	5,167.86	
C026113	0228441	Qualicum River		180,992 acft	28,710.36	
Number of Licences =			3	Total =	215,970 acft	34,258.93
266,399.30						
Domestic Purpose*						
F045497	0243985	Benbow Spring		1,000 GD	0.05	
C045203	0323169	Benbow Spring		100 GD	0.01	
F016373	0212480	Bricker Spring		1,000 GD	0.05	
F007984	0083010	Crocker Creek		500 GD	0.03	
C031697	0270001	Crocker Creek		1,000 GD	0.05	
C043112	0322175	Crocker Creek		500 GD	0.03	
C024332	0220304	Frank & Betty Spring		2,000 GD	0.11	
C054429	0355214	Harris Creek		500 GD	0.03	
F012488	0052943	Helen Spring		500 GD	0.03	
F014746	0166323	Hoare Spring		1,000 GD	0.05	
F014745	0166474	Hoare Spring		1,000 GD	0.05	
F019155	0243618	Little Qualicum River		500 GD	0.03	
F019156	0246724	Little Qualicum River		500 GD	0.03	
C064045	1000650	Little Qualicum River		500 GD	0.03	
F016026	0208186	McBey Creek		2,000 GD	0.11	
F016038	0208187	McBey Creek		500 GD	0.03	
C022736	0208398	McBey Creek		1,500 GD	0.08	
C064744	0346099	Olympic Spring		500 GD	0.03	
C108383	0346100	Olympic Spring		500 GD	0.03	
C064746	0346102	Olympic Spring		500 GD	0.03	
C064747	0346103	Olympic Spring		500 GD	0.03	
C064747	0346103	Olympic Spring		500 GD	0.03	
C064748	0346105	Olympic Spring		500 GD	0.03	
C064749	0346106	Olympic Spring		500 GD	0.03	
C064751	0346108	Olympic Spring		500 GD	0.03	
C064752	0346109	Olympic Spring		500 GD	0.03	
C064753	0346110	Olympic Spring		500 GD	0.03	
C064754	0346111	Olympic Spring		500 GD	0.03	
C064755	0346112	Olympic Spring		500 GD	0.03	
C064750	0370771	Olympic Spring		500 GD	0.03	
C108384	1000287	Olympic Spring		500 GD	0.03	
C100854	1001145	Olympic Spring		500 GD	0.03	
C064068	1000657	Sagon Springs		1,250 GD	0.07	
C064044	1000553	Waring Springs		750 GD	0.04	
C110251	0171073	Whisky Creek		500 GD	0.03	
F108891	0178044	Whisky Creek		500 GD	0.03	
F070339	0231081	Whisky Creek		500 GD	0.03	
F050918	0300725	Whisky Creek		500 GD	0.03	
C038899	0309151	Whisky Creek		500 GD	0.03	
C040907	0316221	Whisky Creek		500 GD	0.03	
Number of Licences =			40	Total =	27,100 GD	1.43
22.48						
Industrial Purpose						
C107094	1001717	Kinkade Creek (STOCKWATERING)		500 GD	0.03	
C107642	0341718	Little Qualicum River		2,000 GD	0.11	
C064043	1000553	Waring Springs (STOCKWATERING)		500 GD	0.03	
C049998	0245738	Whisky Creek		1,500 GD	0.08	
Number of Licences =			4	Total =	4,500 GD	0.24
7.46						
Irrigation Purpose						
F045497	0243985	Benbow Spring		3.1 acft	0.49	
C045203	0323169	Benbow Spring		5 acft	0.79	
C051529	0341865	Crocker Creek		0.25 acft	0.04	
C053985	0355598	Foch Creek		0.25 acft	0.04	
C056044	0365695	Little Qualicum River		80 acft	12.69	
F016200	0197530	Nielsen Brook		0.25 acft	0.04	

LICENCE NUMBER	FILE NUMBER	SOURCE	NUMBER OF LICENCES	QUANTITY/ UNITS	LITRES/SEC.	DEMAND (dam ³ /year)
C100904	1001293	Whisky Creek		0.25 acft	0.04	
Number of Licences =			8	Total =	89.1 acft	14.13
Land Improvement Purpose						
C061479	1000455	Annie & Eveno Creek		135 acft	21.41	
C026115	0229629	Hunts Creek		0 TF		
Number of Licences =			2	Total =	135 acft	21.41
				+	0 TF	166.52
Storage Purpose						
C072630	1000925	Foch Creek		0.25 acft	0.04	
C107094	1001717	Kinkade Creek		0.67 acft	0.11	
C026114	0228441	Qualicum River		142,000 acft	22,525.18	
C100904	1001293	Whisky Creek		0.25 acft	0.04	
Number of Licences =			4	Total =	142,001.17 acft	22,525.36
						175,158.44
Waterworks Purpose*						
C039791	0300472	Crocker Creek		21,000 GD	1.10	
C045726	0316428	Crocker Creek		43,500 GD	2.29	
C039960	0310754	Little Qualicum River		200,000 GD	10.52	
C102092	1001460	Little Qualicum River		70,000 GD	3.68	
C063919	1000143	Olympic Spring		60,000 GD	3.16	
Number of Licences =			5	Total =	394,500 GD	20.75
						327.21
Total Demand =					56,842.26	442,191.33

* Based on the assumption that the demand is the authorized maximum daily licenced divided by 2 to estimate the average daily demand and multiplied by 365 days to determine the annual demand.

** The rate (litres/sec) is based on an estimated 90 day period demand assuming that storage, industrial, and irrigation demands are totally withdrawn over the 90 day period.

APPENDIX E: Low Flow Licenced Water Demand by Drainage Area

(June 1996)

DRAINAGE/ PURPOSE	LICENCED QUANTITY	*LOW FLOW (litres/sec)	*DEMAND (dam ³)
Little Qualicum River			
Conservation	34,978.51 acft	Non - consumptive	
Domestic	10,600.00 GD (max day)	0.56	8.79
Industrial	3,000.00 GD	0.16	4.98
Irrigation	88.10 acft	13.98	108.67
Storage	0.67 acft	-0.11	-0.83
Waterworks	270,000.00 GD (max day)	14.20	223.95
Total Consumption		28.79	345.57
Whiskey Creek			
Domestic	5,500.00 GD (max day)	0.29	4.56
Industrial	1,500.00 GD	0.08	2.49
Irrigation	1.00 acft	0.16	1.23
Storage	0.50 acft	-0.08	-0.62
Waterworks	64,500.00 GD (max day)	3.39	53.50
Total Consumption		3.84	61.17
Annie Creek			
Domestic	3,500.00 GD (max day)	0.18	2.90
Land Improvement	135.00 acft	Non - consumptive	
Total Consumption		0.18	2.90
Westglade Brook			
Domestic	7,500.00 GD (max day)	0.39	6.22
Waterworks	60,000.00 GD	3.16	49.77
Total Consumption		3.55	55.99
Qualicum River			
Conservation	180,991.74 acft	Non - consumptive	
Land Improvement	Total Flow	Non - consumptive	
Storage	142,000.00 acft	-22,525.18	-175,157.00
Total Consumption		-22,525.18	-175,157.00

* Based on an estimated 90 day period demand assuming that: irrigation and industrial demands are totally withdrawn over the 90 day period; domestic ad municipal waterworks demand is the authorized licenced maximum daily for 90 days; authorized storage balances demand and, therefore, is a negative demand over the 90 days; land improvement and conservation are non-consumptive and, therefore, have no demand.

APPENDIX F: Pending Water Licence Applications

(June 1996)

LICENCE NUMBER	FILE NUMBER	SOURCE	QUANTITY/ UNITS	LITRES/ SEC	DEMAND (dam ³ /year)
Waterworks*					
Z109102	1001812	Little Qualicum River	1,506,849 GD		
		Total =	1,506,849 GD	79.28	1,249.84
Industrial**					
Z108206	1001782	ZZ Pond (69383) (PONDS) (Whisky Creek area)	24,000 AN 24,000 GD	(file is missing, assumed GD)	
		Total =	24,000 GD	1.26	39.81
Land Improvement***					
Z109928	1001858	ZZ Swamp (71063) (Whisky Creek area)	0.502 acrf		
		Total =	0.502 acrf	0.08	0.62
		TOTAL DEMAND =		80.62	1,290.28

* Based on the assumption that the demand is the authorized maximum daily licenced divided by 2 to estimate the average daily demand and multiplied by 365 days to determine the annual demand.

** The rate (litres/sec) is based on an estimated 90 day period demand assuming that the licenced quantities are totally withdrawn over the 90 day period.

*** Non-consumptive demand.

APPENDIX G: Fish Screening Requirements

FISH SCREENING DIRECTIVE

Government of Canada
Department of Fisheries and Oceans

WATER INTAKE FISH PROTECTION FACILITIES

The Department of Fisheries and Oceans has prepared this document as a guide to assist in the design and installation of water intakes and fish screening in British Columbia and the Yukon Territory to avoid conflicts with anadromous fish. Additional precautions must be taken at marine intake locations where entrainment of fish larvae, such as eulachon and herring larvae, is a possibility. The screening criteria constitutes the Department's policy regarding the design and construction requirements pursuant to Section 28 of the Fisheries Act.

PROVISIONS OF THE FISHERIES ACT - SECTION 28

Every water intake, ditch, channel or canal in Canada constructed or adapted for conducting water from any Canadian fisheries waters for irrigating, manufacturing, power generation, domestic or other purposes, shall, if the Minister deems it necessary in the public interest, be provided at its entrance or intake with a fish guard or a screen, covering or netting, so fixed as to prevent the passage of fish from any Canadian fisheries waters into such water intake, ditch, channel or canal.

The fish guard, screen, covering or netting shall have meshes or holes of such dimensions as the Minister may prescribe, and shall be built and maintained by the owner or occupier of the water intake, ditch, channel or canal subject to the approval of the Minister or such officer as the Minister may appoint to examine it.

The owner or occupier of the water intake, ditch, channel or canal shall maintain the fish guard, screen, covering or netting in a good and efficient state of repair and shall not permit its removal except for renewal or repair, and during the time such renewal or repair is being effected, the sluice or gate at the intake or entrance of the water intake, ditch, channel or canal shall be closed in order to prevent the passage of fish into the water intake, ditch, channel or canal.

PROCEDURES FOR INSPECTION AND APPROVAL OF INTAKE STRUCTURES

Diversions less than 0.0283 cms (one cubic foot per second): The intake structure shall be constructed in accordance with specifications indicated herein. Upon completion of construction and prior to operation the owner shall contact a local representative of the Department of Fisheries and Oceans to arrange for on-site inspection and approval of the installation. Permanently submerged screens must be inspected prior to installation.

Diversions greater than 0.0283 cms (one cubic foot per second): The owner shall submit to the Department of Fisheries and Oceans 2 sets of detailed plans of the proposed installation for review and approval prior to fabrication. Design drawings are required whenever the diversion quantity exceeds 0.0283 cms (1.0 cfs) or 817,200 L/day (180,000 Igpd) for industrial diversions (calculated on the basis of 8 hours/day) or 123,350 cm³ (100 ac.- ft./year) for irrigation diversions (calculated on the basis of 100 days/year and 12 hours/day). The plans shall contain the following information:

1. Intake structure location and dimensions.
2. Maximum discharge capacity of diversion.
3. Screen dimensions.
4. Mesh size.
5. Screen material.
6. Fabrication details.
7. Minimum and maximum water levels at the intake site.
8. Provision for bypassing fish.

The intake structure shall then be constructed in accordance with the approved plans. Upon completion of construction and prior to operation, the owner shall contact the local representative of the Department of Fisheries and Oceans to arrange for on-site inspection and approval of the installation. Permanently submerged screens must be inspected prior to installation.

SPECIFICATIONS FOR INTAKE STRUCTURES WITHOUT PROVISION FOR AUTOMATIC CLEANING

1. Screen Material: The screen material shall be either stainless steel, galvanized steel, aluminum, brass, bronze, or monel metal. Stainless steel is preferred since corrosion is greatly reduced.
2. Screen Mesh Size: Clear openings of the screen (the space between strands) shall not exceed 2.54 mm (0.10 inch). The open screen area shall not be less than 50% of the total screen area. The following square-mesh wire cloth screens are recommended:
 - 7 mesh, 1.025 mm (0.041 inch) wire, 51% open, 2.54 mm (0.10 inch) openings; or
 - 8 mesh, 0.875 mm (0.035 inch) wire, 52% open, 2.25 mm (0.09 inch) openings; or
 - 8 mesh, 0.700 mm (0.028 inch) wire, 60% open, 2.54 mm (0.10 inch) openings.
3. Screen Area: A minimum unobstructed screen area (gross area) of 0.93 square metre (10 square feet) shall be provided for each 0.0283 cms (1cfs) of water entering the intake. The required screen area shall be installed below minimum water level. Screen area lost by framing shall not be included as part of the unobstructed screen area.
4. Screen Support: The screen shall be adequately supported with stiffeners or back-up material to prevent excessive sagging.
5. Screen Protection: The intake structure shall, where necessary, be equipped with a trash rack or similar device to prevent damage to the screen from floating debris, ice, etc.
6. Screen Accessibility: The screen shall be readily accessible for cleaning and inspection. Screen panels or screen assemblies must be removable for cleaning, inspection and repairs.
7. Allowable Openings: The portion of the intake structure which is submerged at maximum water level shall be designed and assembled such that no openings exceed 2.54 mm (0.10 inch) in width.

8. Design and Location: The design and location of the intake structure shall be such that a uniform flow distribution is maintained through the total screen area.
9. Fish Bypass: The intake shall be designed to provide a transverse velocity (the component of the velocity parallel and adjacent to the screen face) to lead fish to a bypass or past the screens before they become fatigued. In no case should the transverse velocity be less than double the velocity through the screen.

SPECIFICATIONS FOR INTAKE STRUCTURES WITH PROVISIONS FOR AUTOMATIC CLEANING

The specifications are identical to those for intake structures without provisions for automatic cleaning except that the minimum unobstructed screen area (gross area) of 0.23 square metre (2.5 square feet) need only be provided for each 0.0283 cms (1 cfs) of water entering the intake. However, a regular cleaning and maintenance schedule is required to ensure seals and screen panels remain in good repair preventing impingement and entrainment of fish and debris.

For these self-cleaning intake structures, the location, design and juvenile fish avoidance system all affect operating characteristics. The final design, therefore, may incorporate modifications reflecting the best current technology available for minimizing adverse impact upon the fisheries resource.

ALTERNATE FISH PROTECTION FACILITIES

Enquiries concerning the Department's requirements for indirect intakes, such as infiltration galleries and wells, for salt water ocean intakes, and for new methods or devices for screening intake structures should be directed to the Department of Fisheries and Oceans, Senior Habitat Management Biologist.

Conversion Factors:

1 cubic foot per second (cfs) = 449 U.S. gallons per minute (U.S. gpm).
= 374 Imperial gallons per minute (I gpm).
= 1.98 acre feet per day (Ac.-Ft./day).
= 28.3 litres per second (L/sec.).
= 0.0283 cubic metres per second (cms)

0.10 inch = 3/32" (approx.) = 2.54 millimetres

Addresses for Correspondence and Approvals

1. Senior Habitat Management Biologist
Fraser River, Northern B.C. and Yukon Division
Department of Fisheries and Oceans
Room 330, 80 - 6th Street
New Westminster, B.C. V3L 5B3
Phone: 666-6479
2. Senior Habitat Management Biologist
South Coast Division
Department of Fisheries and Oceans
3225 Stephenson Point Road
Nanaimo, B.C. V9T 1K3
Phone: 756-7270
3. Senior Habitat Management Biologist
North Coast Division
Department of Fisheries and Oceans
Room 109, 417 - 2nd Avenue West
Prince Rupert, B.C. V6J 1G8
Phone: 624-9385

Other Federal and Provincial agencies having jurisdiction in water withdrawals and construction pertaining to watercourses in British Columbia include:

1. Transport Canada
Canadian Coast Guard.
2. B.C. Ministry of Environment
Fish and Wildlife Management.
3. B.C. Ministry of Environment
Water Management.
4. B.C. Ministry of Agriculture and Food.
5. B.C. Ministry of Lands, Parks and Housing.

It may be necessary that several or all these agencies also be solicited for approvals prior to the installation of a water intake.

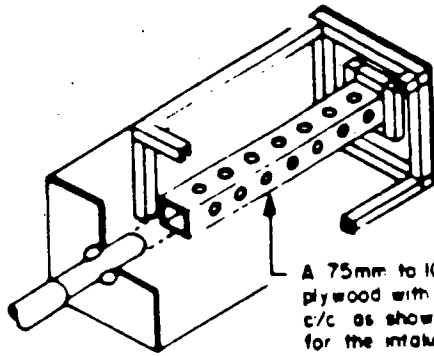

A 75mm to 100mm square bar of 19mm plywood with 25mm dia holes at 75mm c/c as shown, may be substituted for the intake pipe below

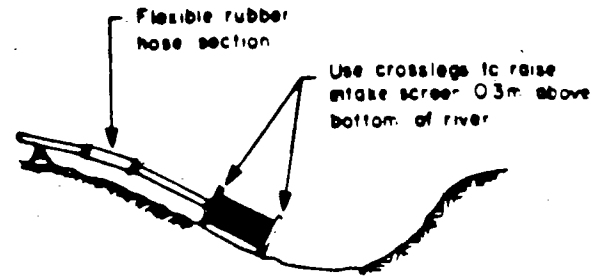

STANDARD INSTALLATION

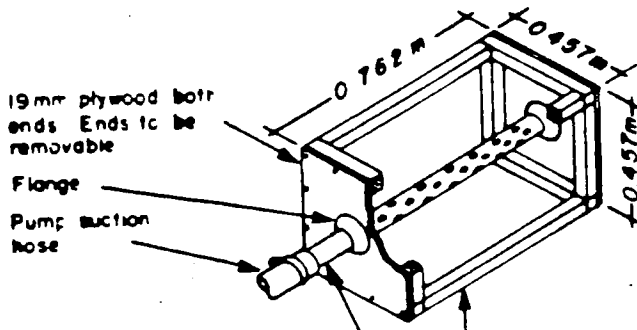

19mm plywood bolt ends Ends to be removable

Flange
Pump suction hose

50mm - 100mm std pipe with the section inside the screen box perforated with 16mm dia holes at 50mm to 100mm c/c staggered

50mm x 50mm painted framing covered on 4 sides with bronze screen (wire cloth) stretched tight and fastened to the framing only Plywood ends to be removable Use 8 mesh wire cloth with 0.70mm or 0.64mm dia wire

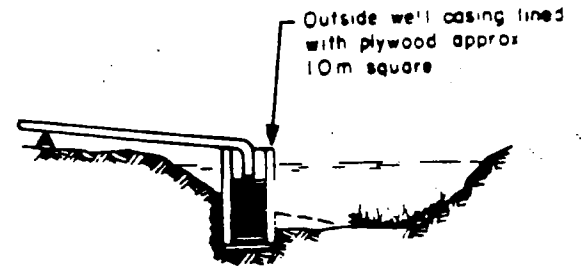

INSTALLATION IN SHALLOW WATER
MUDDY OVERGROWN BOTTOM

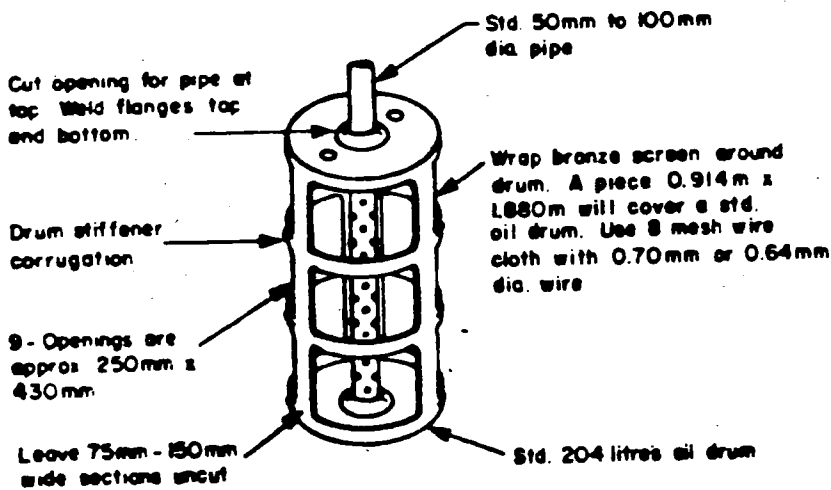

Cut opening for pipe at top. Weld flanges top and bottom.

Drum stiffener corrugation

9 - Openings are approx 250mm x 430mm

Leave 75mm - 150mm wide sections uncut

Std. 50mm to 100mm dia pipe

Wrap bronze screen around drum. A piece 0.914m x 1.880m will cover a std. oil drum. Use 8 mesh wire cloth with 0.70mm or 0.64mm dia. wire

Std. 20-litre oil drum

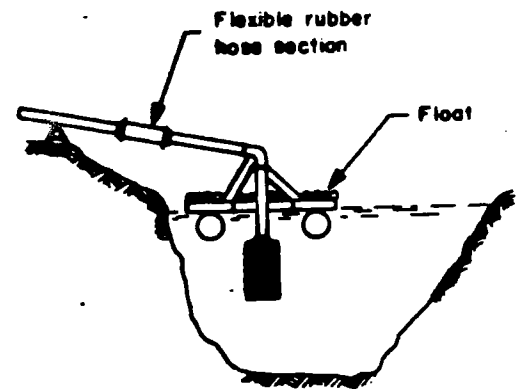

INSTALLATION IN DEEP WATER

NOTE

1. Oil drum shall be thoroughly washed out or steam cleaned before cutting openings
2. All loose rust shall be removed and the drum coated with metal primer. Two coats of machinery enamel or epoxy paint shall be applied before covering with wire cloth

NOTE

All screens shall be installed below minimum water level, shall be easily accessible for cleaning, and shall be cleared of debris at regular intervals

SMALL STATIONARY WATER INTAKE SCREENS

(For pumps of a capacity less than 28.3 L/sec [1cfs, 449 U.S. or 374 Igpm])

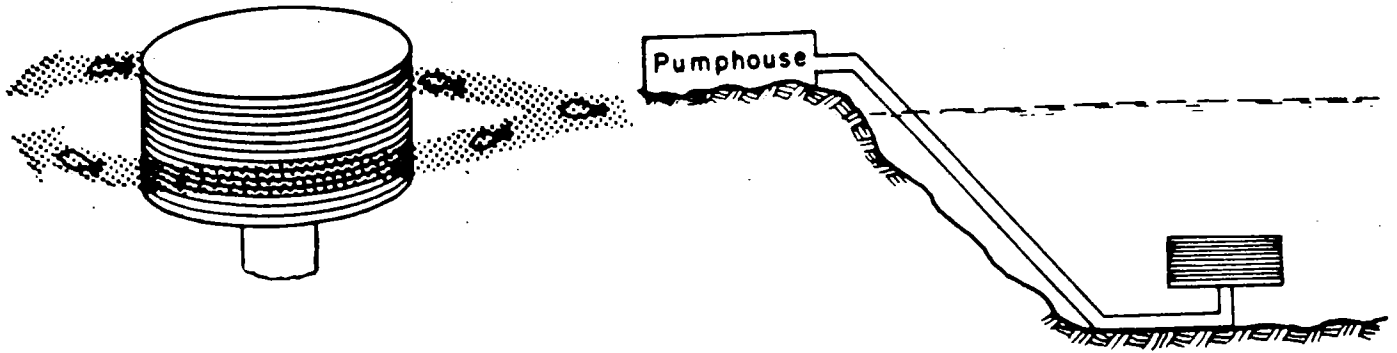

DEEP WATER WELL SCREEN

May be installed in lakes and the ocean.

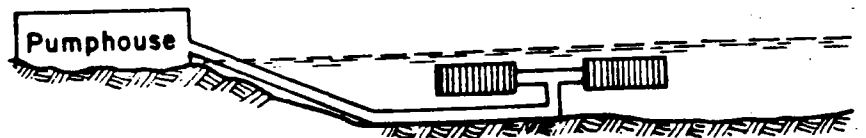
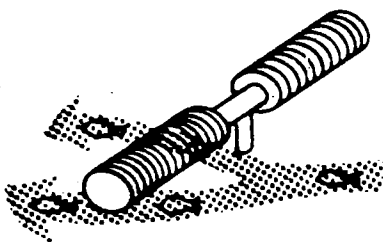

SHALLOW WATER WELL SCREEN

May be installed in lakes, pools, and stable areas in rivers.

Totally submerged cylindrical shaped stainless steel well screens provide for high intake capacity and large percentage of open area permitting water to enter at low velocities. Slot opening shall not exceed 2.54 mm (0.10 inch).

VERTICAL PANEL SCREENS

May be installed in rivers, lakes and the ocean. Generally, requires coarse trashracks, a sluice gate in river installations, double sets of guide-rails, and standby screen panels to allow for cleaning and repairs.

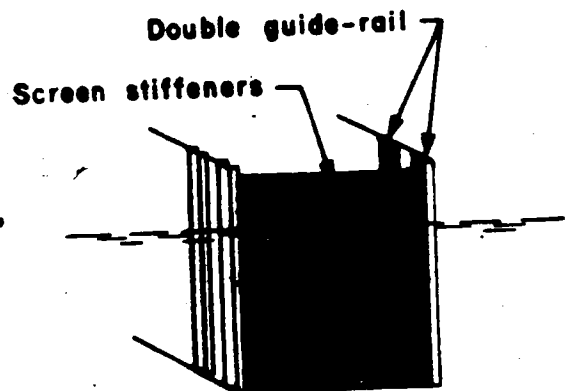

LARGE STATIONARY WATER INTAKE SCREENS

(For pumps of a capacity more than 28.3 L/sec [1 cfs, 449 U.S. or 374 Igpm])

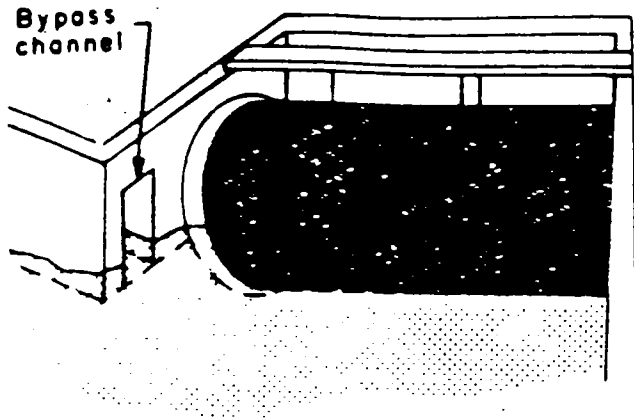

REVOLVING DRUM SCREEN, HORIZONTAL AXIS

Generally, installed to divert fish from irrigation canals. Can be driven by a small motor or by a paddle wheel. To avoid juvenile fish impingement, a bypass channel is required near the front of the screen. Rubber seals are necessary along the base and sides.

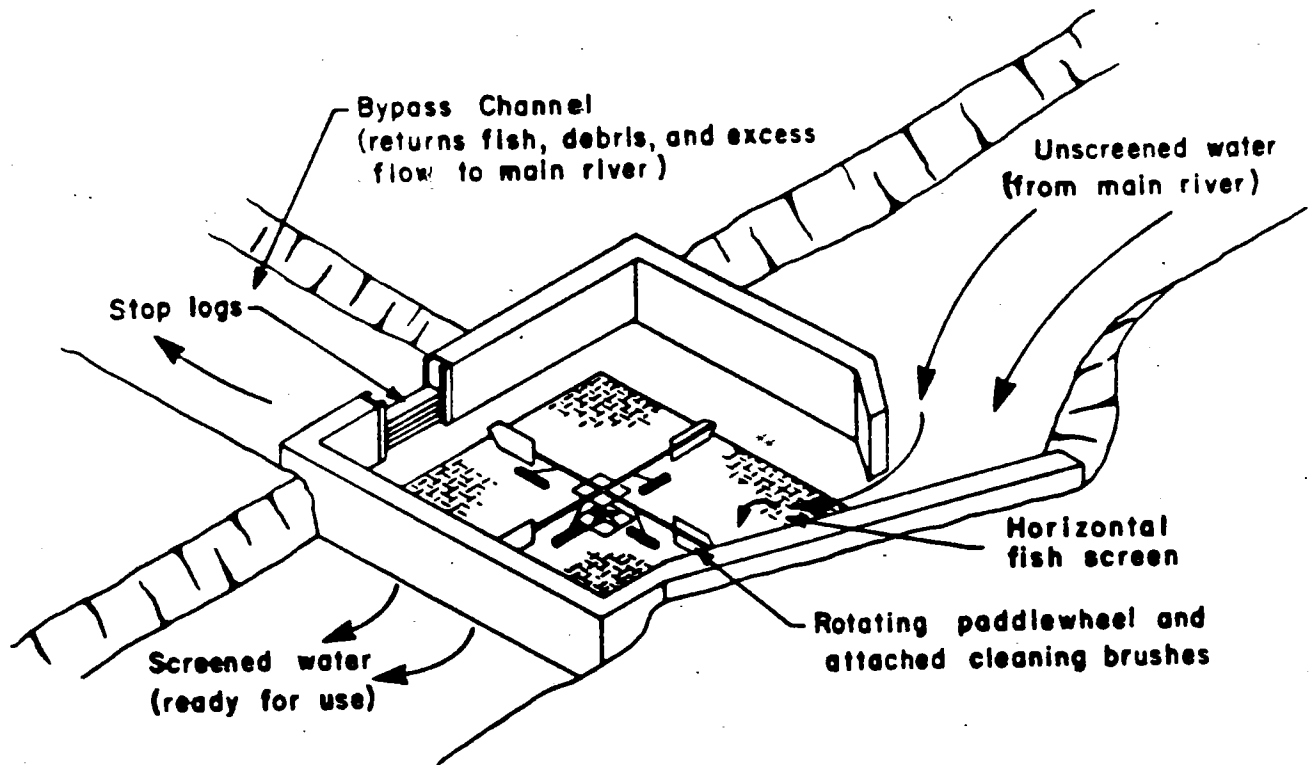

FINNIGAN SCREEN

The horizontal, self-cleaning Finnigan Screen is another concept, generally installed to divert fish from irrigation or enhancement projects. The stationary horizontal screen is kept clean by a set of brushes attached to a revolving paddle wheel powered by the water current entering the structure. A portion of the flow, the suspended debris, and fish are directed to the bypass channel. The remainder of the flow passes through and below the screen for use as required.

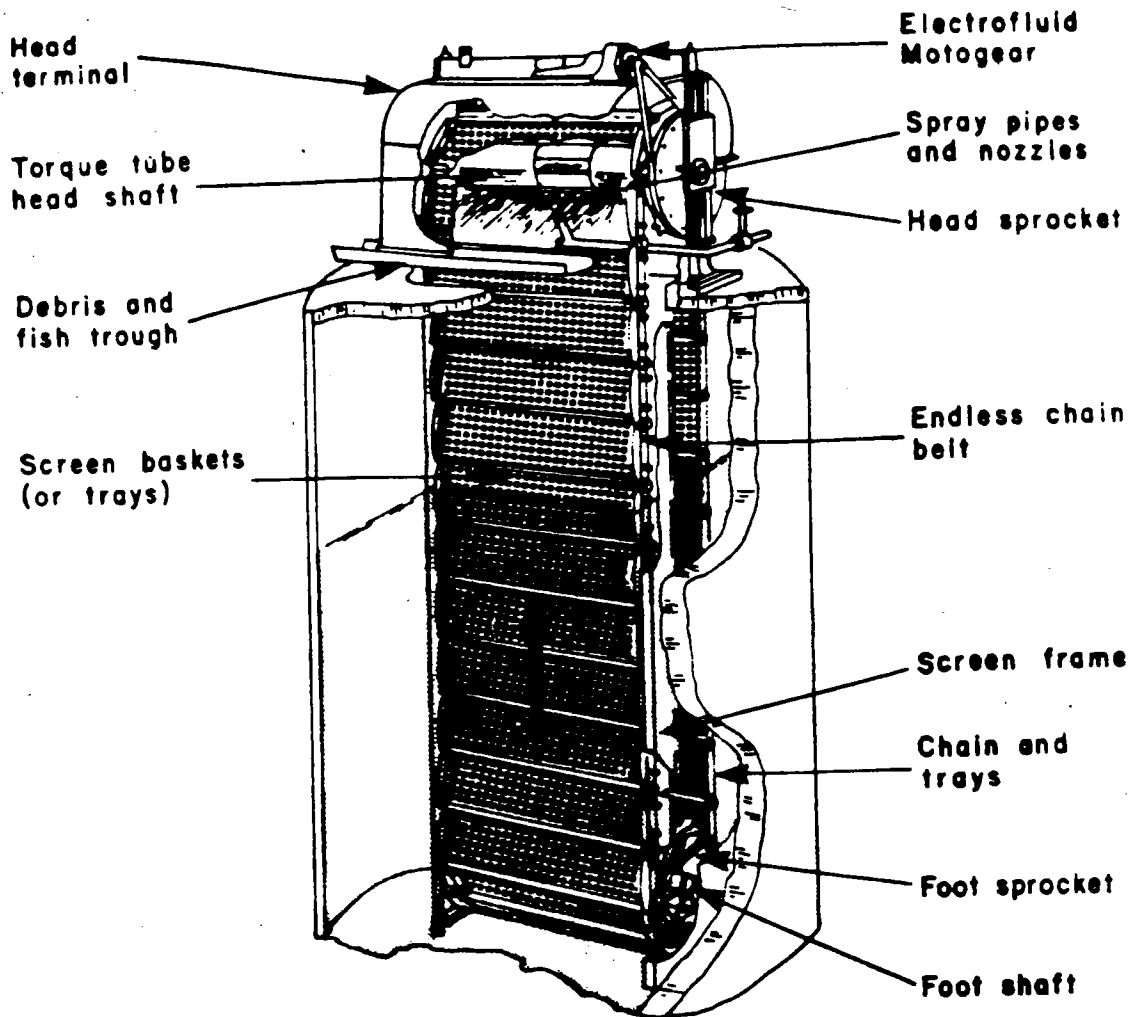

CONVENTIONAL VERTICAL TRAVELLING SCREEN

May be installed in rivers, lakes and the ocean. A common screening method utilized by industry, these self-cleaning mechanical screens with modifications can prevent impact upon fish. Mounted flush to the stream bank (shoreline) or as pier intakes within streams and provided with an opening on the downstream end between the intake screens and trashracks, juvenile fish can generally escape entrapment. Rubber panel, side, and boot seals are required to prevent juvenile fish from gaining entry into the pumpwell. A safe bypass system is essential to return juvenile fish with debris back to the watercourse. Automatic controls are also necessary to ensure operation at a specific minimum head differential.

LARGE INDUSTRIAL AND DOMESTIC WATER INTAKE SCREEN